



**Stehle**

**Sistema de cabezales universales Euro catálogo  
con cuchillas de respaldo**

**UC 2020**

**Abrasivo**

**Construcción**

**Madera**

**Tableros**

**Aluminio**

**Acero**

**Plastico**



## Índice

<b>Cabezales Euro</b>		<b>Página</b>
Ejecución estándar en acero		3
Ejecución DUO en aluminio		4
<hr/>		
<b>Cuchillas perfiladas</b>	<b>Ancho: 40 mm</b>	
Cuchillas para hacer galces	16/20/24 x 4 mm	5
Cuchillas perfiladas / deflectores 001t/m099	40 x 4 mm	5 - 21
Cuchillas perfiladas / deflectores 100t/m099	40 x 4 mm	22 - 29
<hr/>		
<b>Cuchillas sin perfilar</b>	<b>Ancho: 40 mm</b>	
Cuchillas sin perfilar	Altura: 45/59 mm	29
<hr/>		
<b>Cuchillas perfiladas</b>	<b>Ancho: 50 mm</b>	
Cuchillas perfiladas/deflectores 500t/m580	50 x 4 mm	30 - 40
<hr/>		
<b>Cuchillas sin perfilar</b>	<b>Ancho: 50 y 60 mm</b>	
Cuchillas sin perfilar	Altura: 50/59 mm	41
<hr/>		
<b>Cuchillas perfiladas</b>	<b>Ancho: 50 mm</b>	
Cuchillas perfiladas /deflectores 200t/m233	50 x 5,5 mm	42 - 47
Cuchillas sin perfilar	Altura: 45 mm	47
<hr/>		
<b>Imágenes</b>		48 - 51
<hr/>		
<b>Embalaje: VA = 2</b>		
<b>Precio por unidad</b>		01/2017 <a href="http://www.stehle-int.com">www.stehle-int.com</a>



## Ejecución

- Cuerpo base de acero
- Cuchillas de acero SP
- Incl. VHW cuchillas para hacer galces, deflectores
- Incl. cuñas, tornillos y llave

## Aplicación

- Para perfilar maderas blandas y duras
- Madera maciza no encolad

## Envío

- Cabezal con cuchillas para hacer galces montados con deflectores y llave en la caja

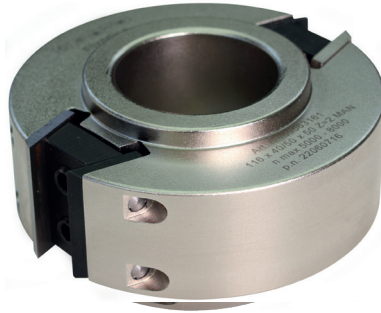

## Indicaciones

- Cuchillas perfiladas con deflectores
- Profundidad del perfil max. 19mm
- Espesor de cuchilla y deflector 4mm, otros espesores son prohibidos

## Sets

- Stehle tiene varios sets de herramientas en su surtido con los perfiles 1-6, 1-12, 1-24, 1-36 enviado en cajas de madera que son disponibles para enviar

Características (Ejecución acero)		Número de pedido
ESTÁNDAR	093 x 40 x 30	Z= 2+2 (acero) 69563162
	116 x 40/50 x 30	Z= 2+2 (acero) 69563160
	116 x 40/50 x 40	Z= 2+2 (acero) 69563163
	116 x 40/50 x 50	Z= 2+2 (acero) 69563161

Características (Sets en cajas)		Número de pedido 6 piezas	Número de pedido 12 piezas
SETS	093 x 40 x 30	Z= 2+2 (acero) 56316206	56316212
	116 x 40/50 x 30	Z= 2+2 (acero) 56316006	56016012
	116 x 40/50 x 40	Z= 2+2 (acero) 56316306	56316312
	116 x 40/50 x 50	Z= 2+2 (acero) 56316106	56316112

Características (Sets en cajas)		Número de pedido 24 piezas	Número de pedido 36 piezas
SETS	093 x 40 x 30	Z= 2+2 (acero) 56316224	56316236
	116 x 40/50 x 30	Z= 2+2 (acero) 56316024	56316036
	116 x 40/50 x 40	Z= 2+2 (acero) 56316324	56316336
	116 x 40/50 x 50	Z= 2+2 (acero) 56316124	56316136



## Ejecución

- Cuerpo base de aluminio
- Cuchillas de metal duro enterizo
- Incl. VHW cuchillas para hacer galces, deflectores y precortadores
- Incl. cuñas adicionales para cuchillas 4,0mm

## Aplicación

- Para perfilar maderas blandas y duras
- Madera maciza no encolada
- Hacer galces en materiales de madera y maderas encoladas

## Envío

- Cabezal con cuchillas para hacer galces montados con deflectores y llave en la caja de plástico

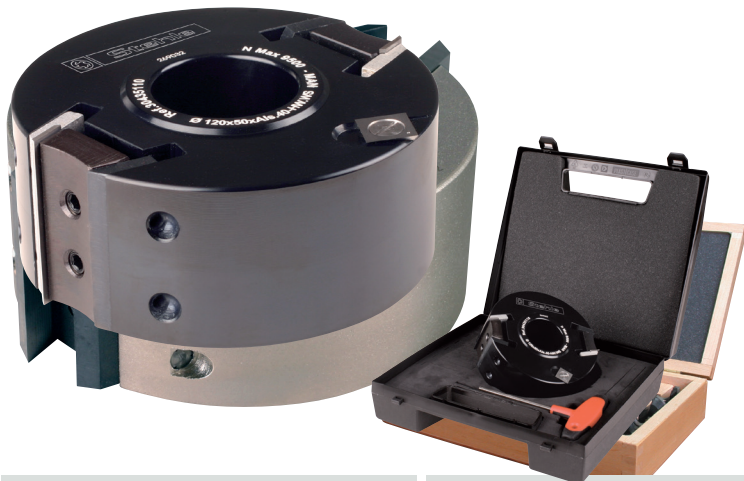

## Indicaciones

- Cuchillas perfiladas con deflectores aplicada por parejas
- Profundidad del perfil max. 19mm
- Espesor de cuchilla y deflector 4mm, cuchillas con espesor 5,5mm se pueden utilizar también

## Sets

- Stehle tiene varios sets de herramientas en su surtido con los perfiles 1-6, 1-12, 1-24, 1-36 enviado en cajas de madera que son disponibles para enviar

El cabezal universal DUO ofrece las siguientes aplicaciones: Hacer galces en materiales de madera (también con recubrimiento) y maderas encoladas. Perfilar maderas macizas no encoladas. En los cabezales de 50mm se puede utilizar las cuchillas de 50x50x4,0 y 50x50x5,5

Características (Ejecución aluminio DUO)		Cuchillas reversibles	Precortadores	Número de pedido	
FRESAS DUO	120 x 40 x 30	Z= 2 + 2 V2	50820040	50820014	30334110
	120 x 50 x 30	Z= 2 + 2 V2	50820050	50820014	30335110
	120 x 40 x 40	Z= 2 + 2 V2	50820040	50820014	30434110
	120 x 50 x 40	Z= 2 + 2 V2	50820050	50820014	30435110
	120 x 40 x 50	Z= 2 + 2 V2	50820040	50820014	30534110
	120 x 50 x 50	Z= 2 + 2 V2	50820050	50820014	30535110



M = Cuchillas perfiladas A = Deflectores

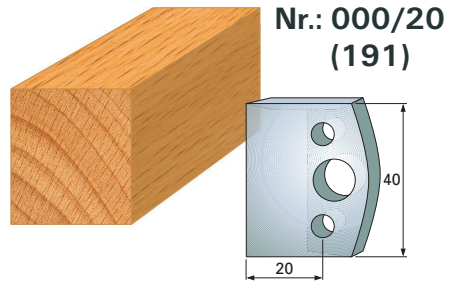
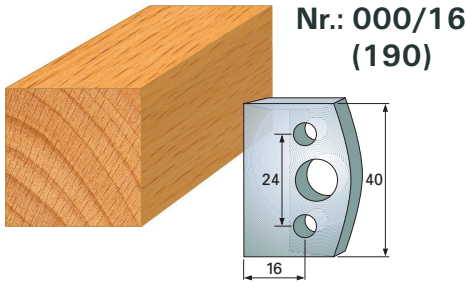

M 40300016  
A 40320016

M 40300020  
A 40320020

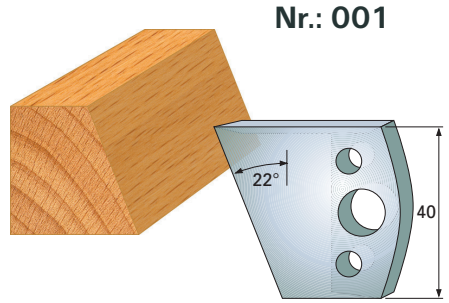
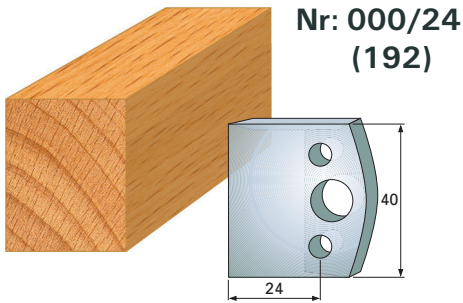

M 40300024  
A 40320024

M 50403001  
A 50403201

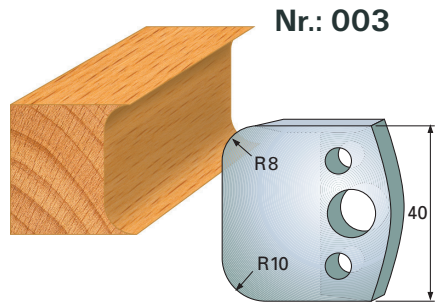
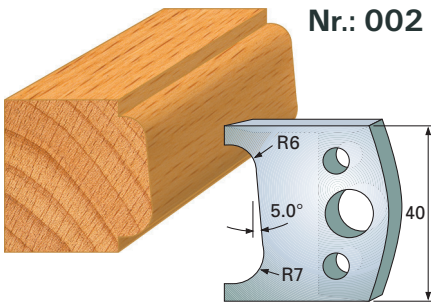

M 50403002  
A 50403202

M 50403003  
A 50403203

M = Cuchillas perfiladas A = Deflectores

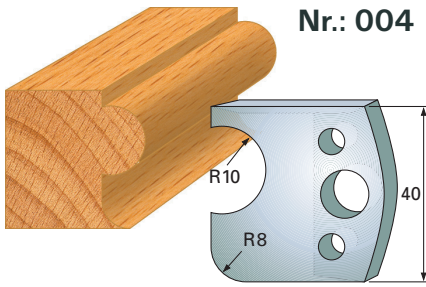

M 50403004  
A 50403204

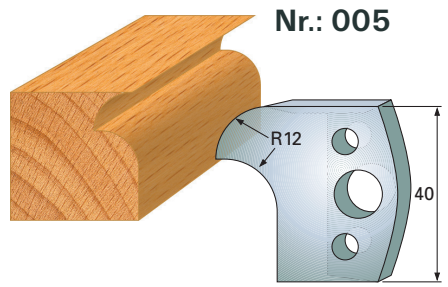

M 50403005  
A 50403205

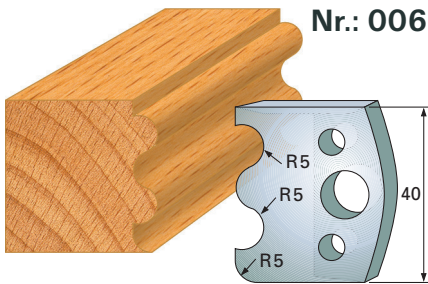

M 50403006  
A 50403206

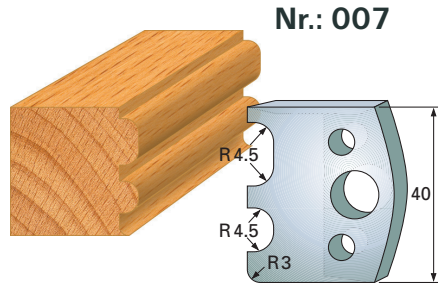

M 50403007  
A 50403207

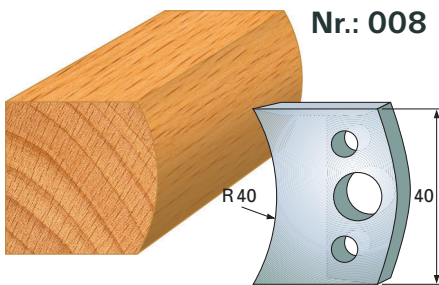

M 50403008  
A 50403208

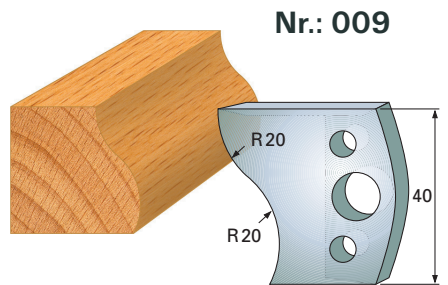

M 50403009  
A 50403209

M = Cuchillas perfiladas A = Deflectores

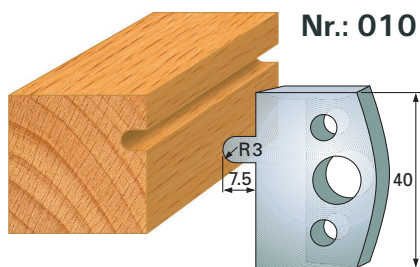

M 50403010  
A 50403210

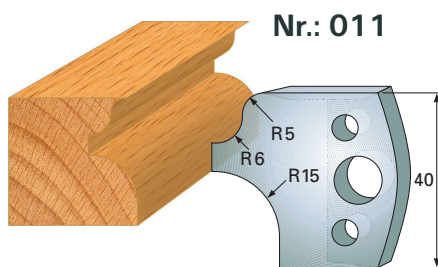

M 50403011  
A 50403211

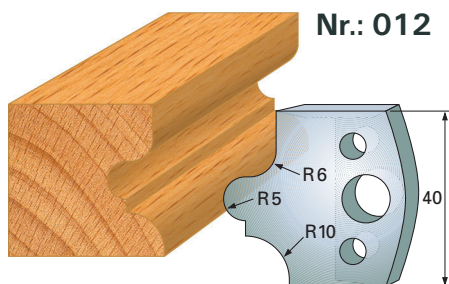

M 50403012  
A 50403212

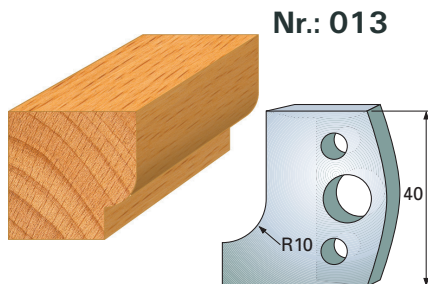

M 50403013  
A 50403213

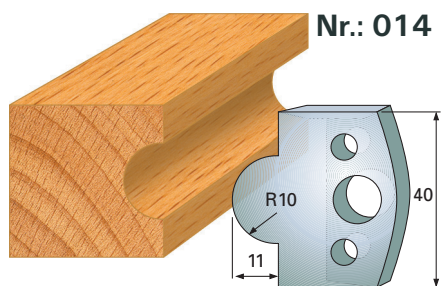

M 50403014  
A 50403214

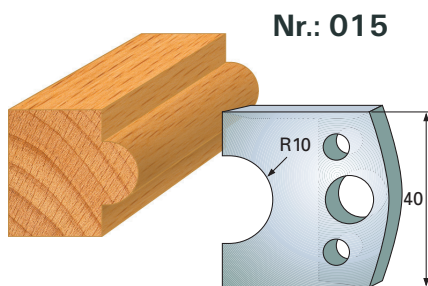

M 50403015  
A 50403215

M = Cuchillas perfiladas A = Deflectores



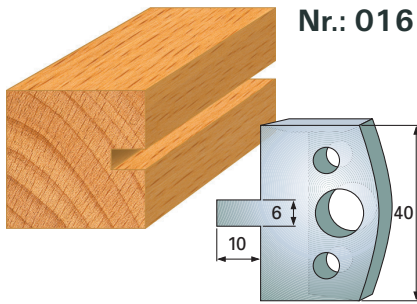

M 50403016

A 50403216

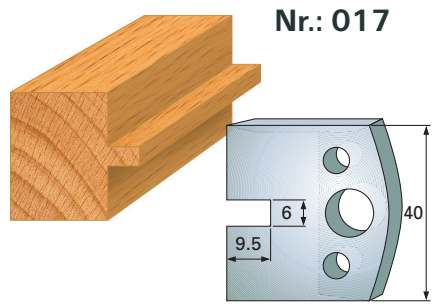

M 50403017

A 50403217

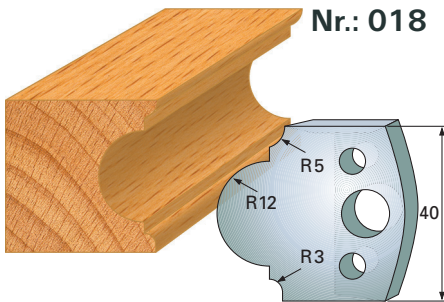

M 50403018

A 50403218

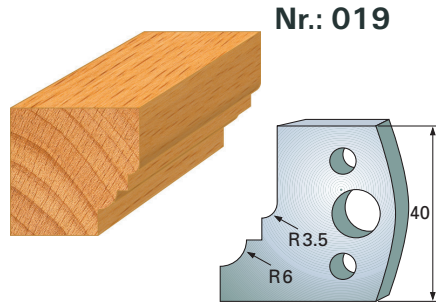

M 50403019

A 50403219

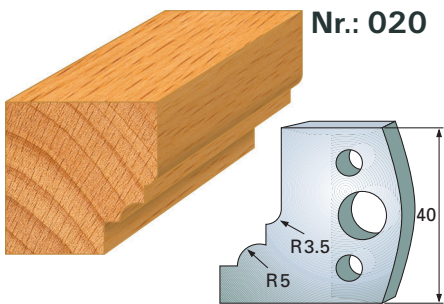

M 50403020

A 50403220

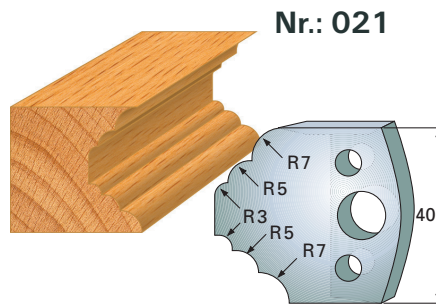

M 50403021

A 50403221

M = Cuchillas perfiladas A = Deflectores

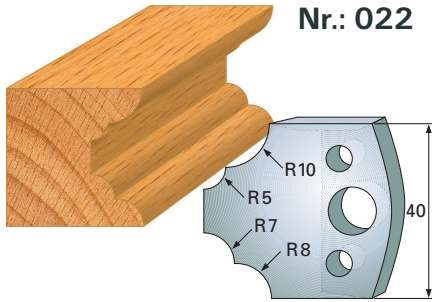

M 50403022  
A 50403222

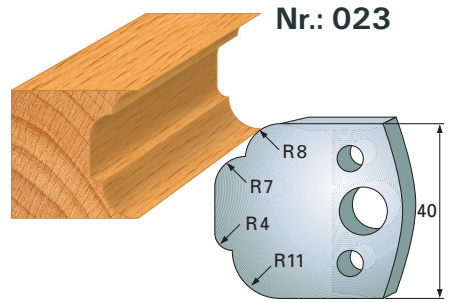

M 50403023  
A 50403223

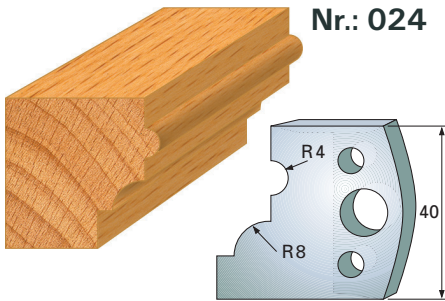

M 50403024  
A 50403224

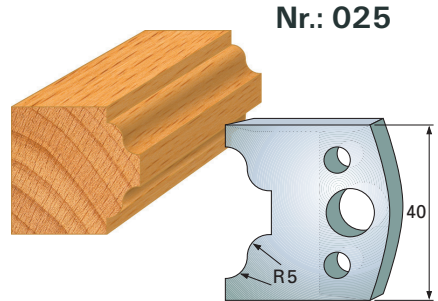

M 50403025  
A 50403225

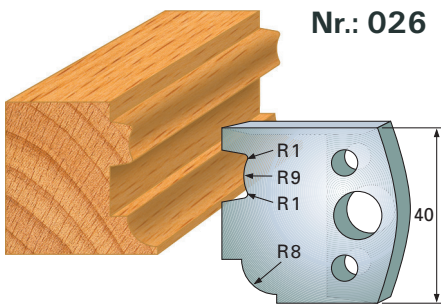

M 50403026  
A 50403226

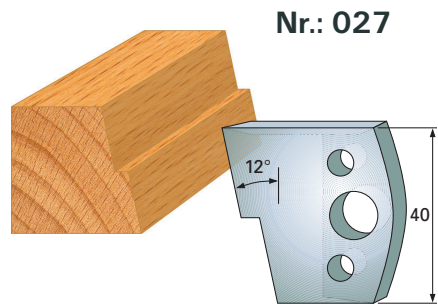

M 50403027  
A 50403227

M = Cuchillas perfiladas A = Deflectores

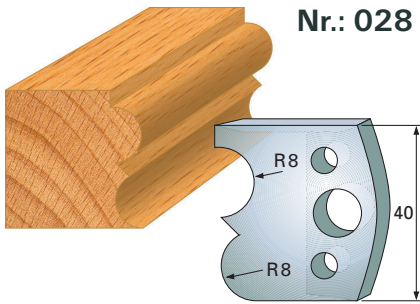

M 50403028

A 50403228

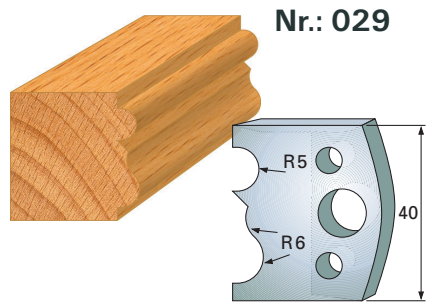

M 50403029

A 50403229

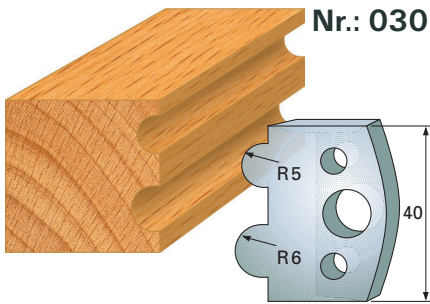

M 50403030

A 50403230

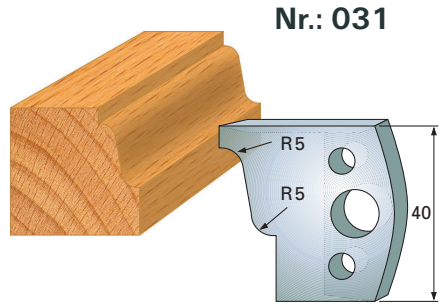

M 50403031

A 50403231

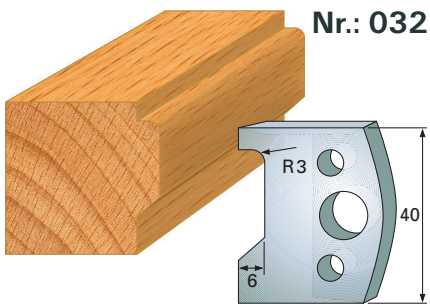

M 50403032

A 50403232

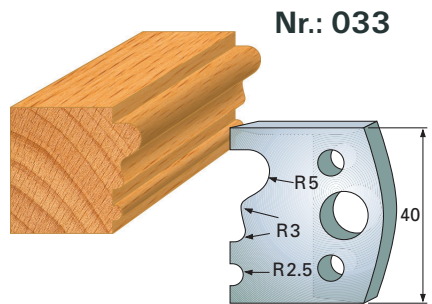

M 50403033

A 50403233

M = Cuchillas perfiladas A = Deflectores

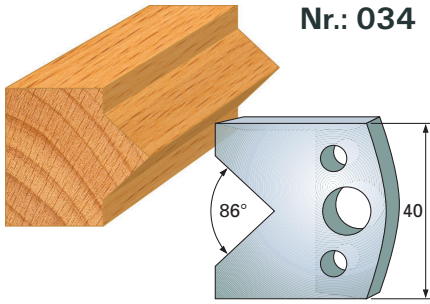

M 50403034  
A 50403234

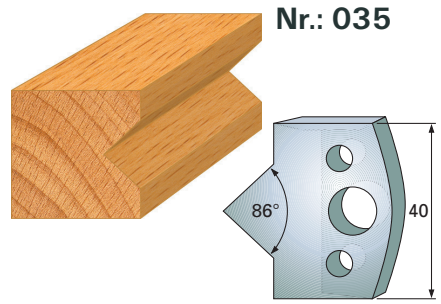

M 50403035  
A 50403235

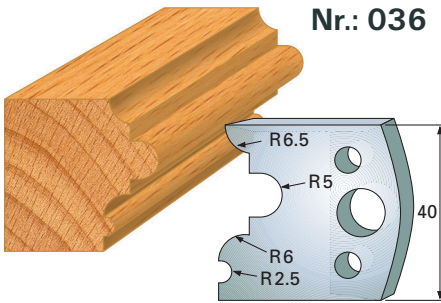

M 50403036  
A 50403236

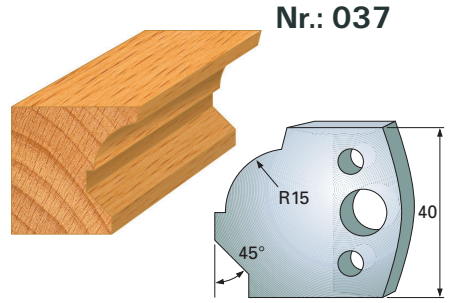

M 50403037  
A 50403237

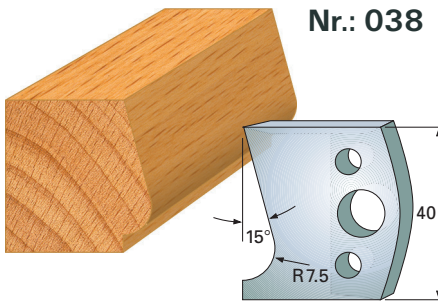

M 50403038  
A 50403238

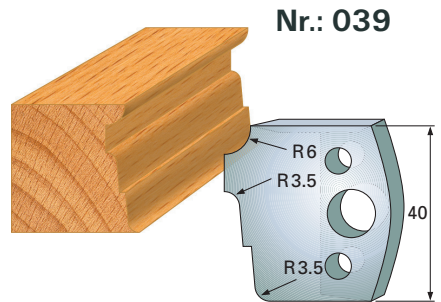

M 50403039  
A 50403239

M = Cuchillas perfiladas A = Deflectores

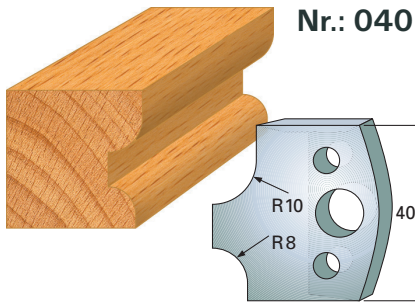

M 50403040

A 50403240

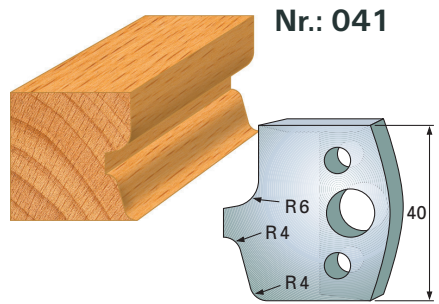

M 50403041

A 50403241

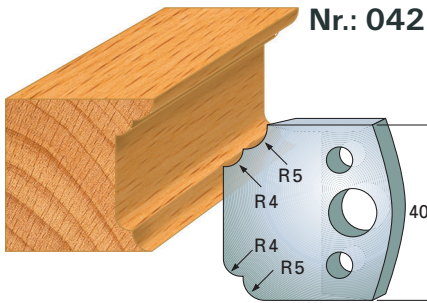

M 50403042

A 50403242

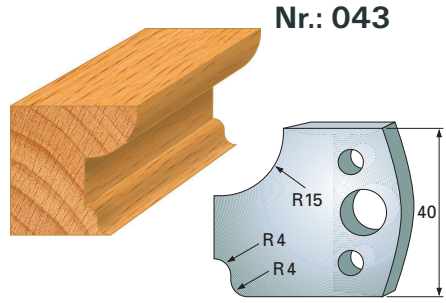

M 50403043

A 50403243

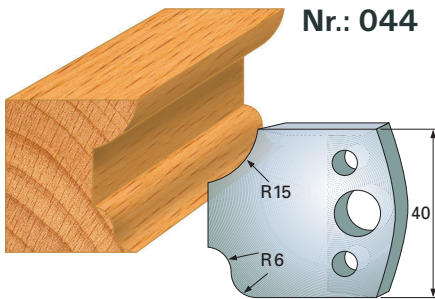

M 50403044

A 50403244

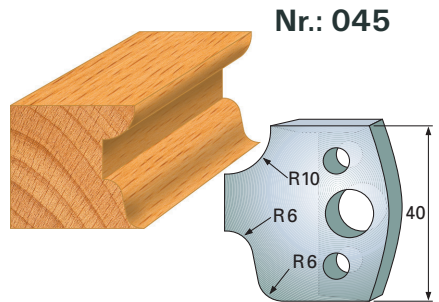

M 50403045

A 50403245

M = Cuchillas perfiladas A = Deflectores

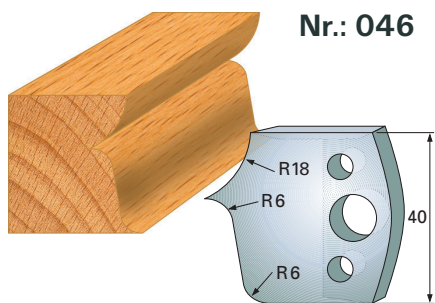

M 50403046  
A 50403246

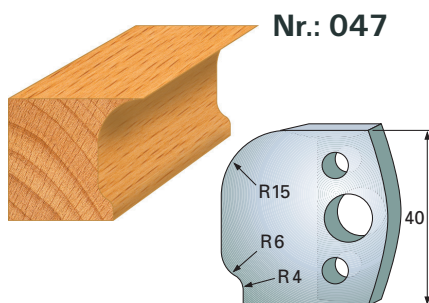

M 50403047  
A 50403247

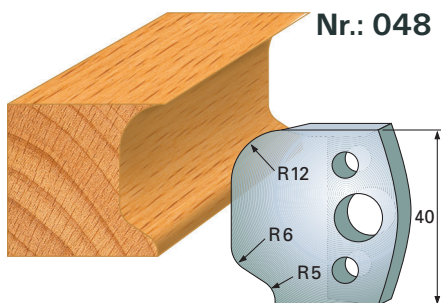

M 50403048  
A 50403248

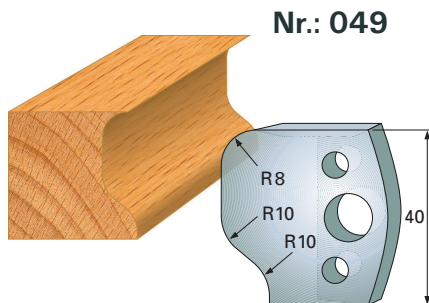

M 50403049  
A 50403249

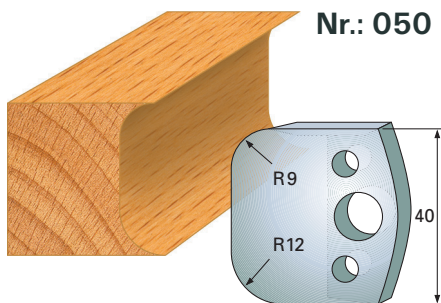

M 50403050  
A 50403250

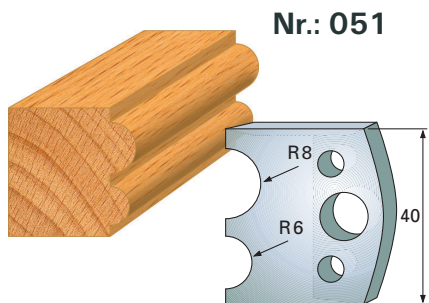

M 50403051  
A 50403251

M = Cuchillas perfiladas A = Deflectores

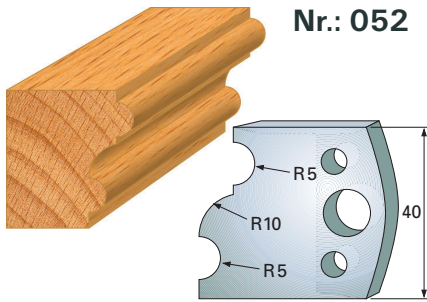

M 50403052

A 50403252

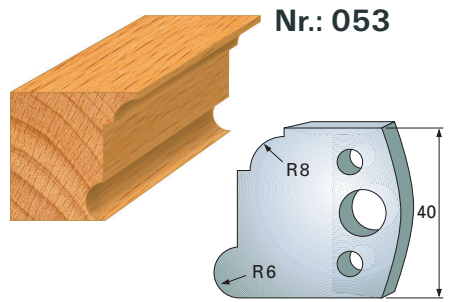

M 50403053

A 50403253

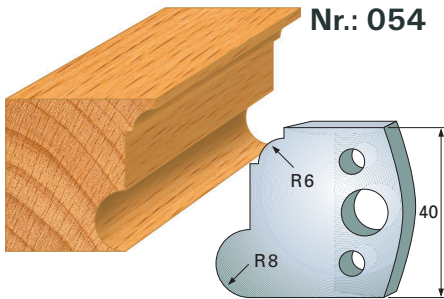

M 50403054

A 50403254

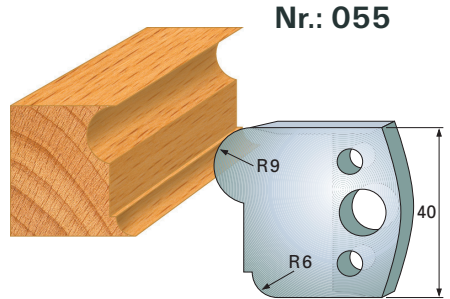

M 50403055

A 50403255

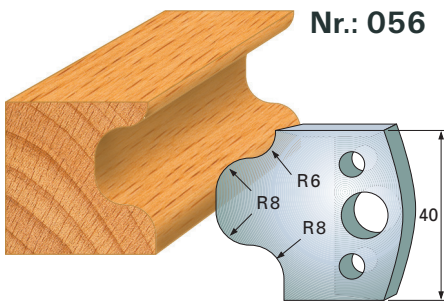

M 50403056

A 50403256

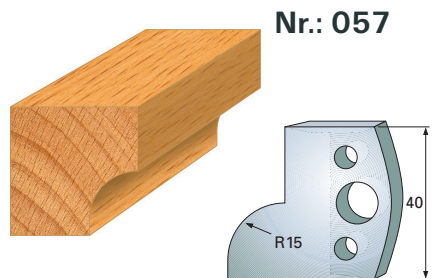

M 50403057

A 50403257

M = Cuchillas perfiladas A = Deflectores

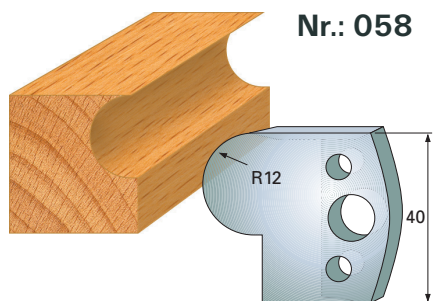

M 50403058

A 50403258

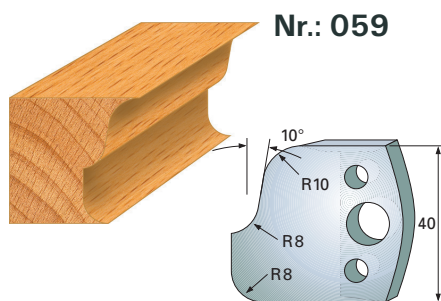

M 50403059

A 50403259

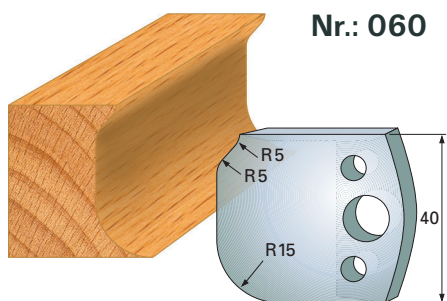

M 50403060

A 50403260

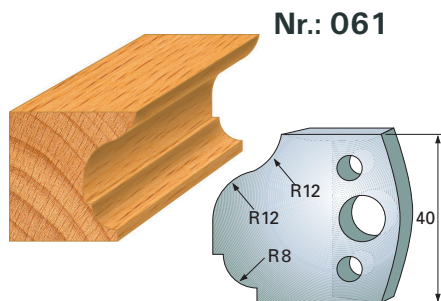

M 50403061

A 50403261

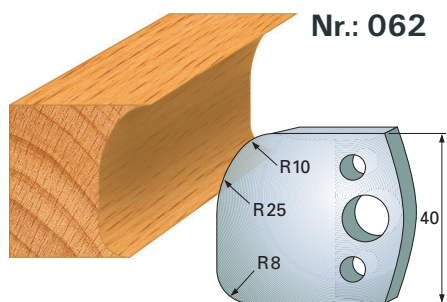

M 50403062

A 50403262

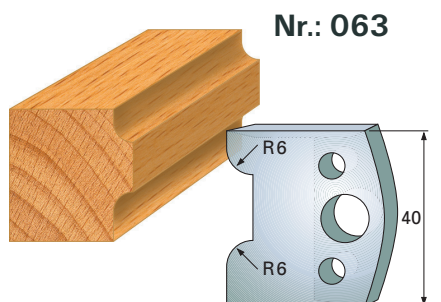

M 50403063

A 50403263

M = Cuchillas perfiladas A = Deflectores



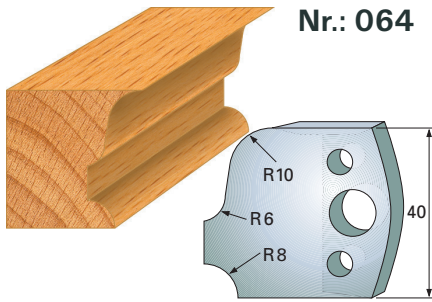

M 50403064  
A 50403264

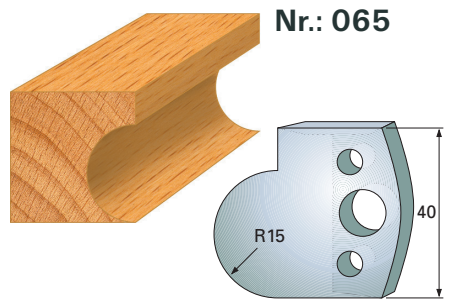

M 50403065  
A 50403265

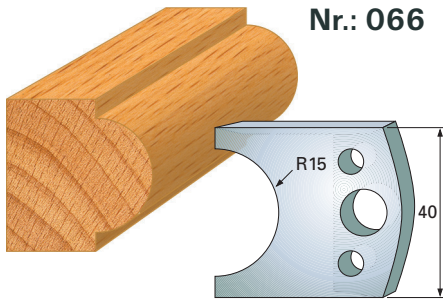

M 50403066  
A 50403266

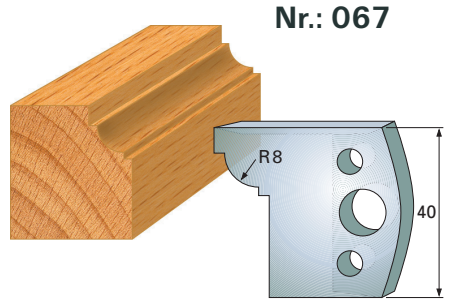

M 50403067  
A 50403267

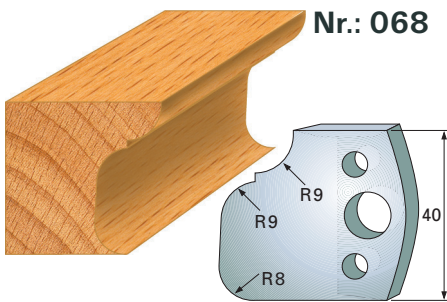

M 50403068  
A 50403268

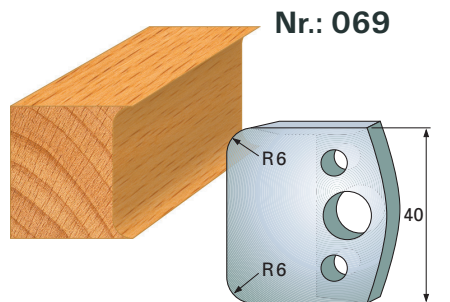

M 50403069  
A 50403269

M = Cuchillas perfiladas A = Deflectores

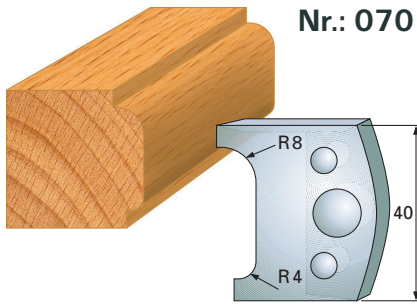

M 50403070  
A 50403270

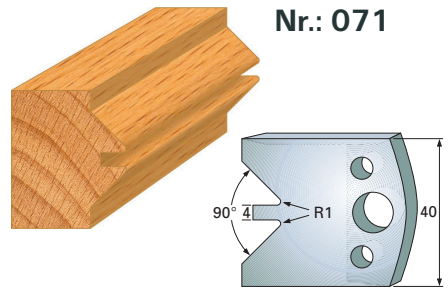

M 50403071  
A 50403271

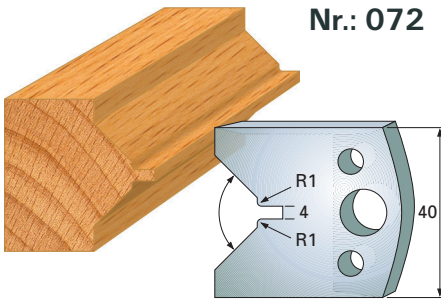

M 50403072  
A 50403272

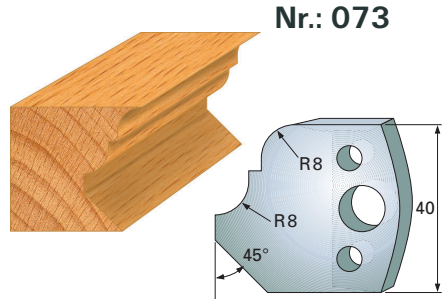

M 50403073  
A 50403273

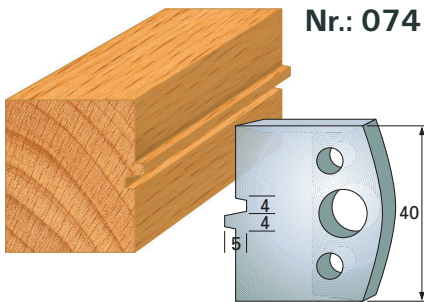

M 50403074  
A 50403274

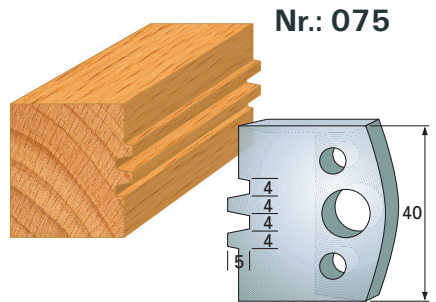

M 50403075  
A 50403275

M = Cuchillas perfiladas A = Deflectores

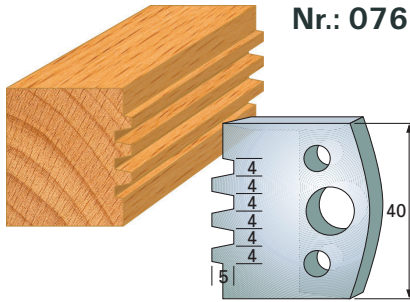

M 50403076

A 50403276

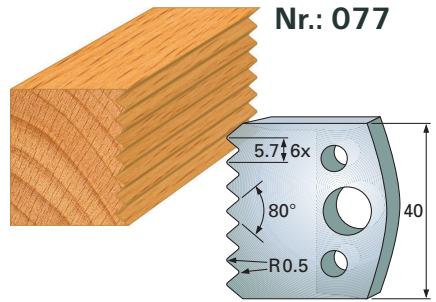

M 50403077

A 50403277

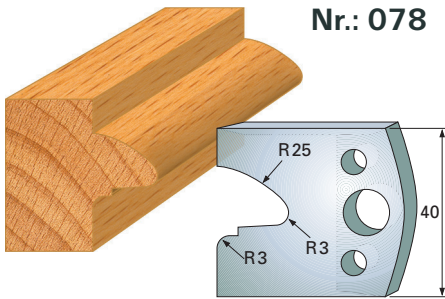

M 50403078

A 50403278

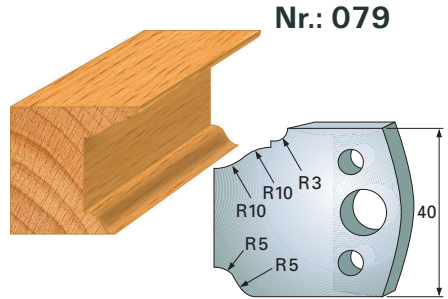

M 50403079

A 50403279

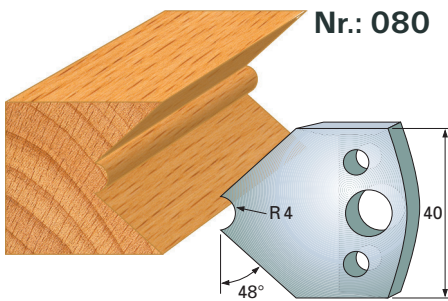

M 50403080

A 50403280

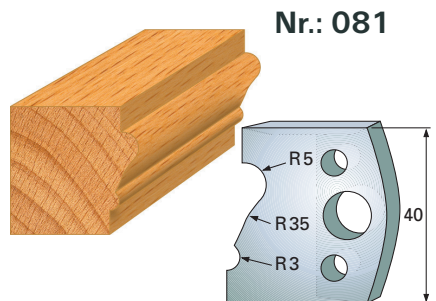

M 50403081

A 50403281

M = Cuchillas perfiladas A = Deflectores

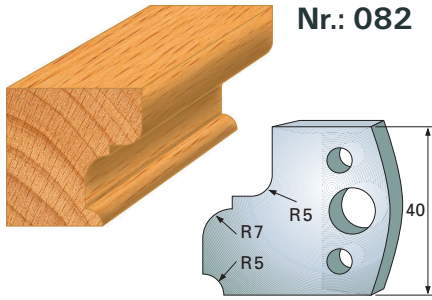

M 50403082  
A 50403282

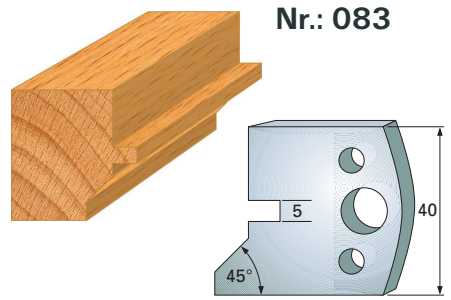

M 50403083  
A 50403283

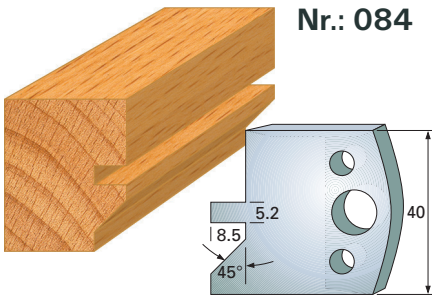

M 50403084  
A 50403284

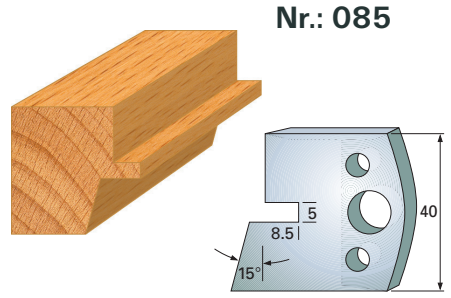

M 50403085  
A 50403285

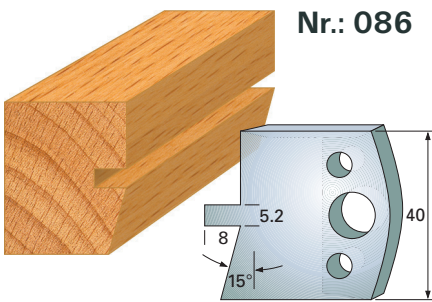

M 50403086  
A 50403286

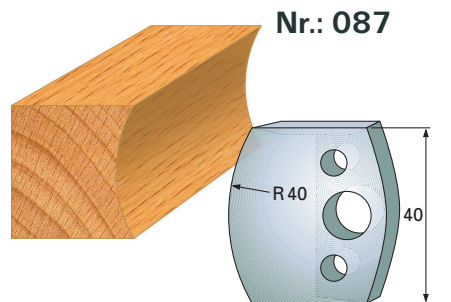

M 50403087  
A 50403287

M = Cuchillas perfiladas A = Deflectores

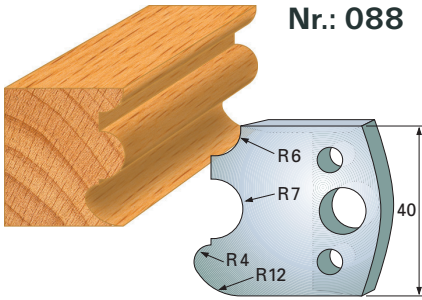

M 50403088  
A 50403288

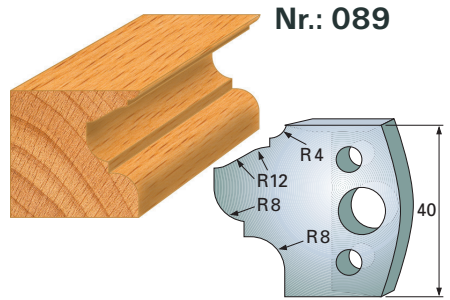

M 50403089  
A 50403289

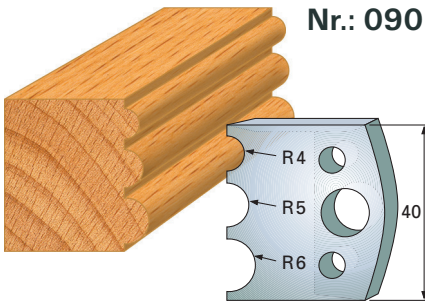

M 50403090  
A 50403290

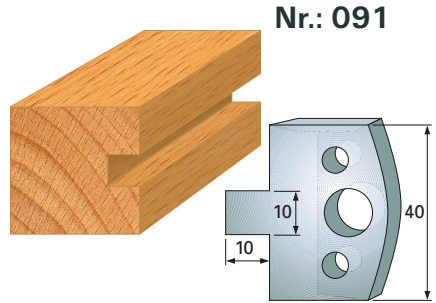

M 50403091  
A 50403291

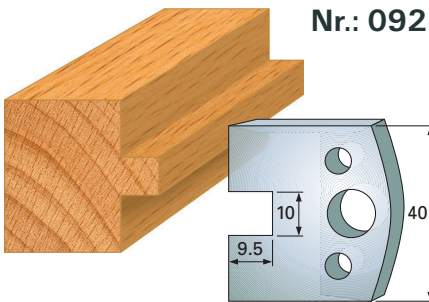

M 50403092  
A 50403292

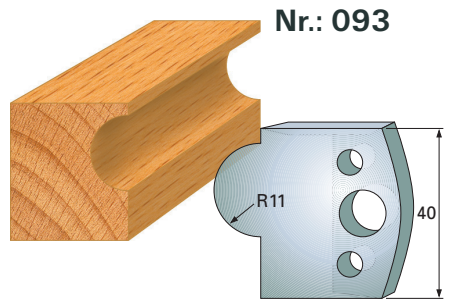

M 50403093  
A 50403293

M = Cuchillas perfiladas A = Deflectores

Nr.: 094

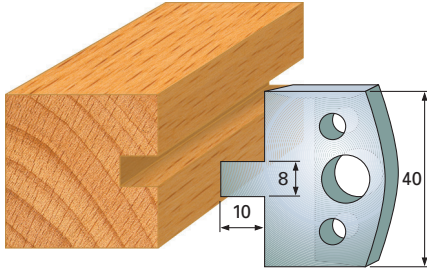

M 50403094  
A 50403294

Nr.: 095

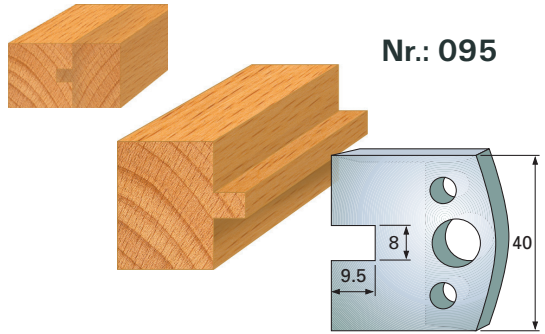

M 50403095  
A 50403295

Nr.: 096

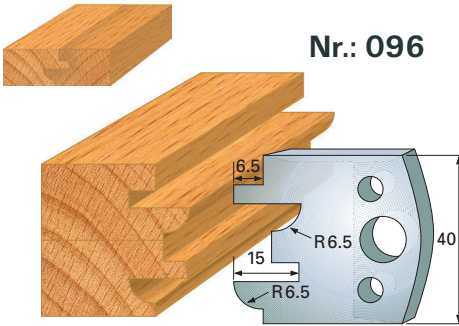

M 50403096 Conterprofil K-1  
A 50403296

Nr.: 097

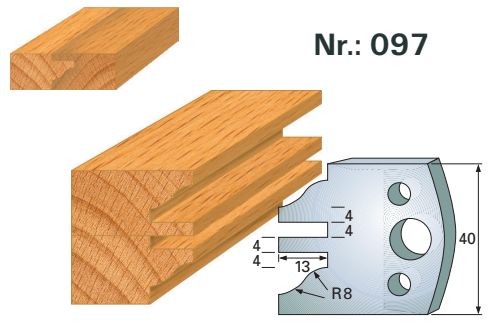

M 50403097 Conterprofil K-2  
A 50403297

Nr.: 098

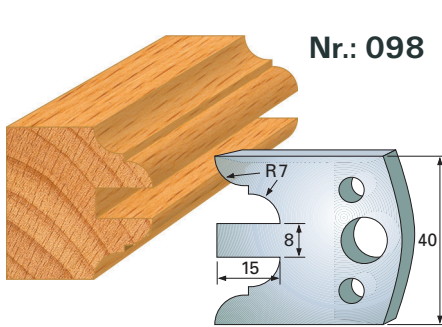

M 50403098 Conterprofil K-3  
A 50403298

Nr.: 099

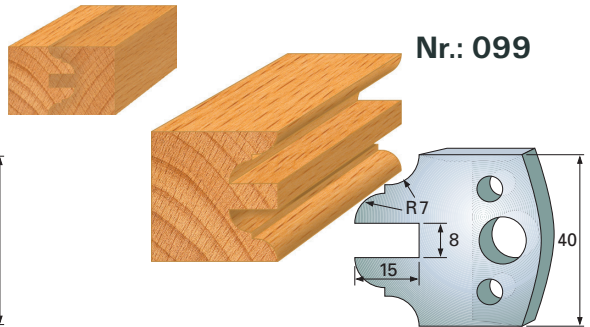

M 50403099 Conterprofil K-4  
A 50403299

M = Cuchillas perfiladas A = Deflectores

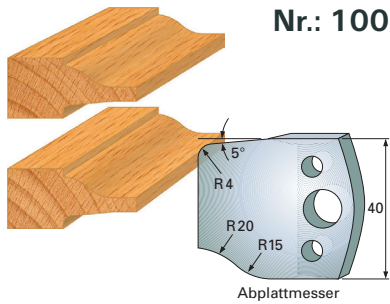

M 50403100

A 50403300

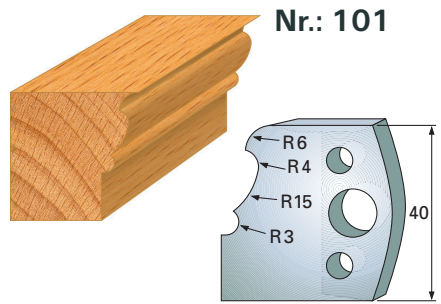

M 50403101

A 50403301

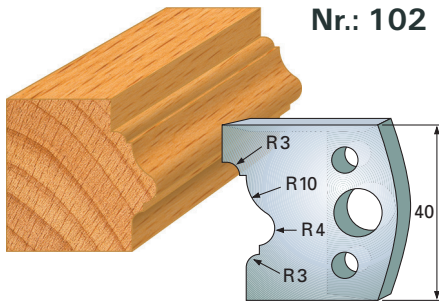

M 50403102

A 50403302

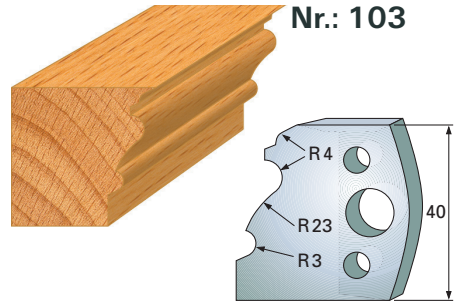

M 50403103

A 50403303

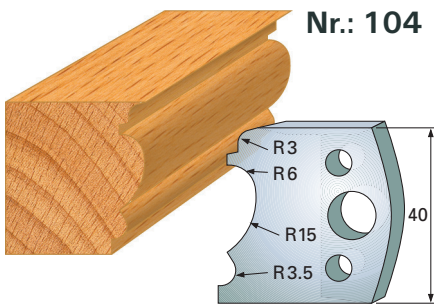

M 50403104

A 50403304

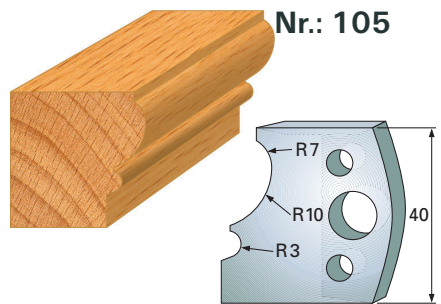

M 50403105

A 50403305

M = Cuchillas perfiladas A = Deflectores

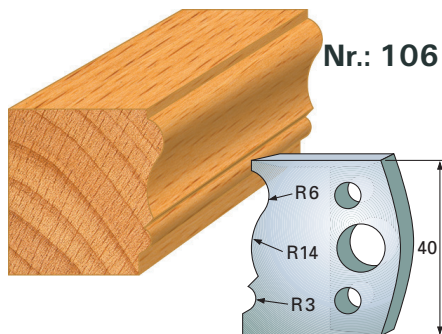

Nr.: 106

M 50403106

A 50403306

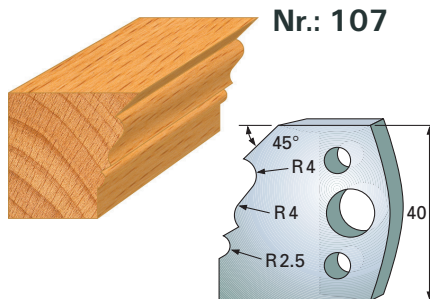

Nr.: 107

M 50403107

A 50403307

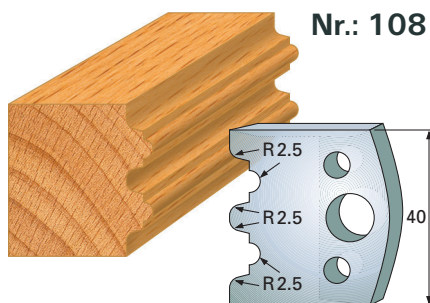

Nr.: 108

M 50403108

A 50403308

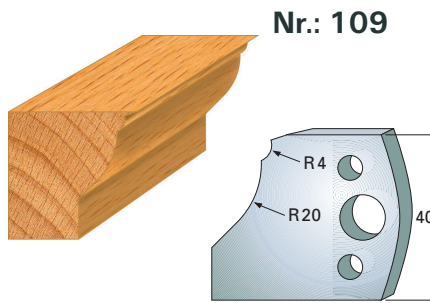

Nr.: 109

M 50403109

A 50403309

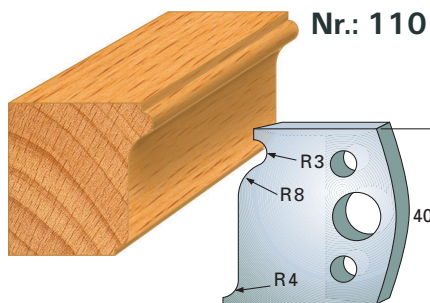

Nr.: 110

M 50403110

A 50403310

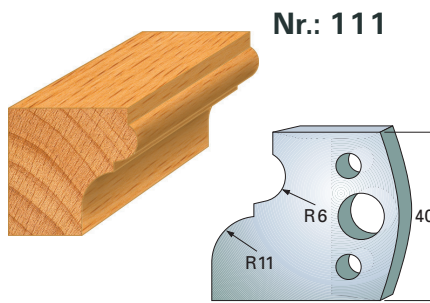

Nr.: 111

M 50403111

A 50403311

M = Cuchillas perfiladas A = Deflectores



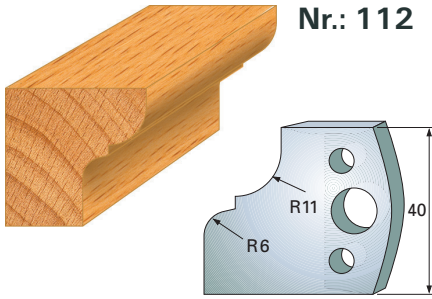

M 50403112  
A 50403312

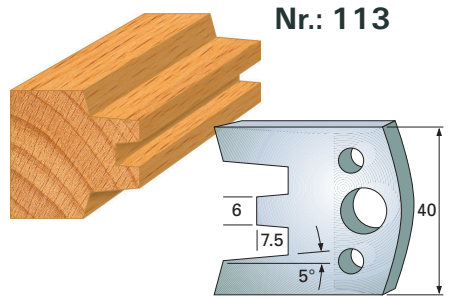

M 50403113  
A 50403313

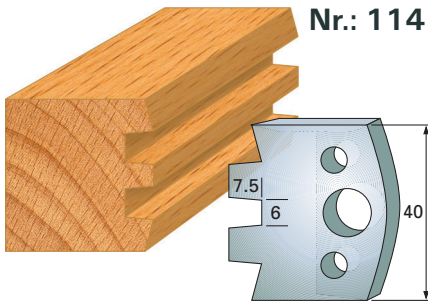

M 50403114  
A 50403314

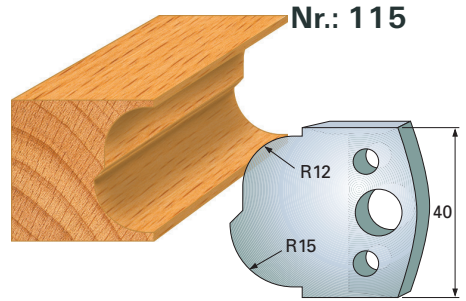

M 50403115  
A 50403315

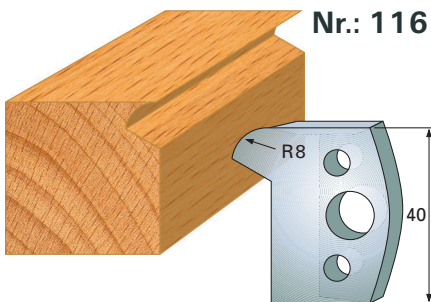

M 50403116  
A 50403316

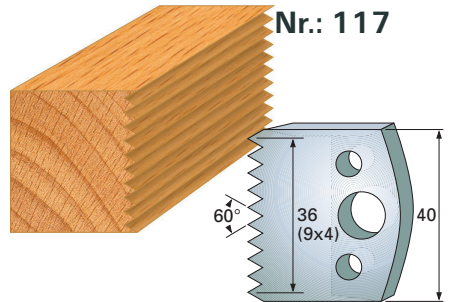

M 50403117  
A 50403317

M = Cuchillas perfiladas A = Deflectores

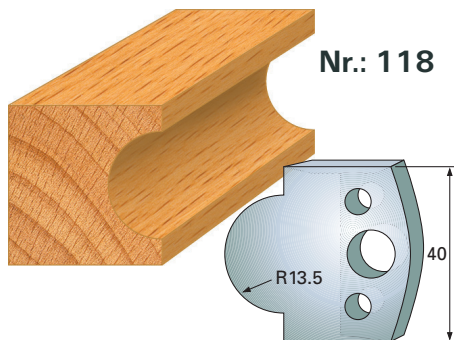

M 50403118  
A 50403318

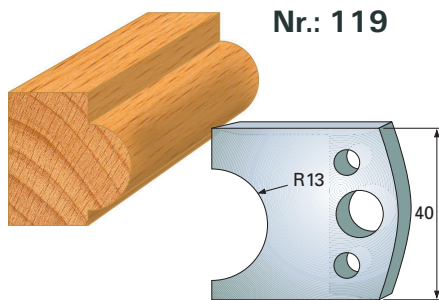

M 50403119  
A 50403319

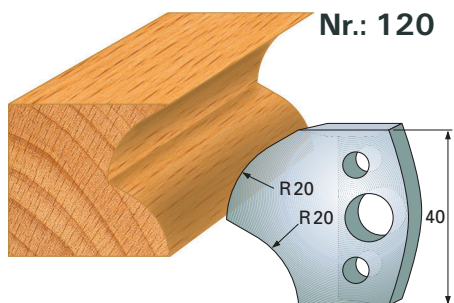

M 50403120  
A 50403320

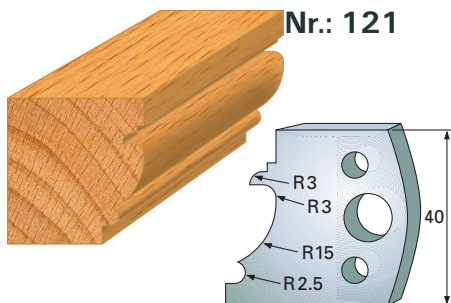

M 50403121  
A 50403321

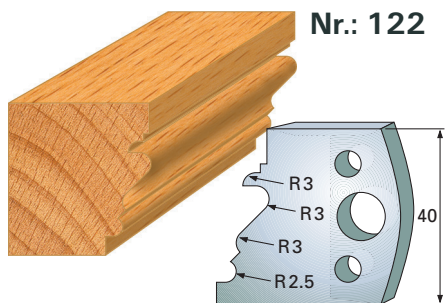

M 50403122  
A 50403322

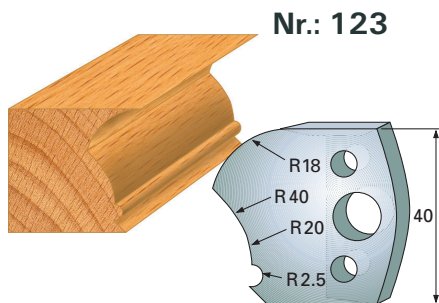

M 50403123  
A 50403323

M = Cuchillas perfiladas A = Deflectores

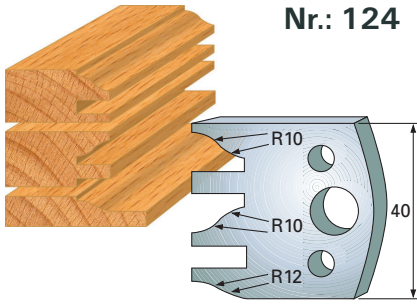

M 50403124  
A 50403324

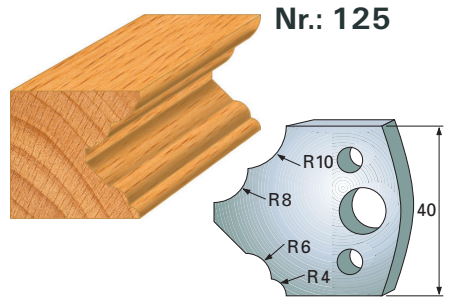

M 50403125  
A 50403325

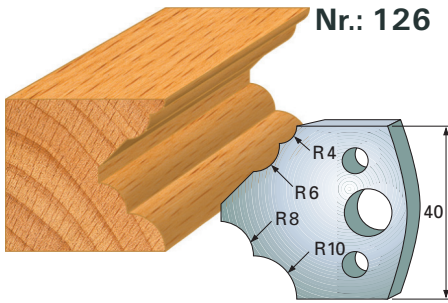

M 50403126  
A 50403326

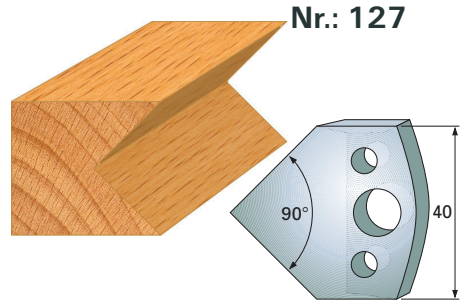

M 50403127  
A 50403327

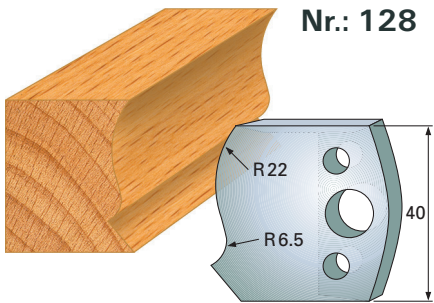

M 50403128  
A 50403328



M 50403129  
A 50403329

M = Cuchillas perfiladas A = Deflectores

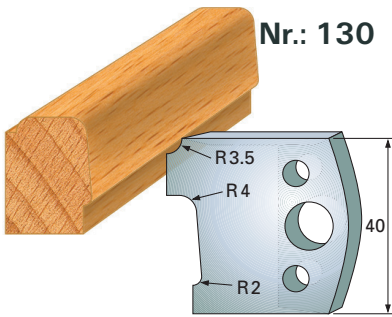

M 50403130  
A 50403330

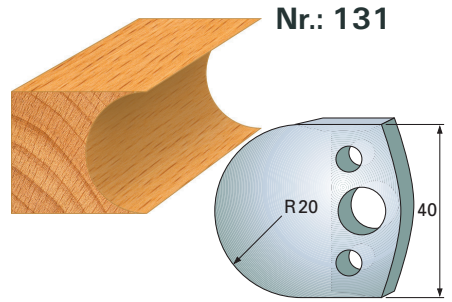

M 50403131  
A 50403331

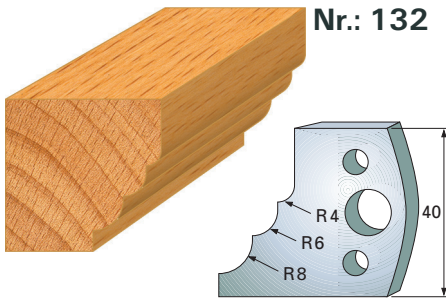

M 50403132  
A 50403332

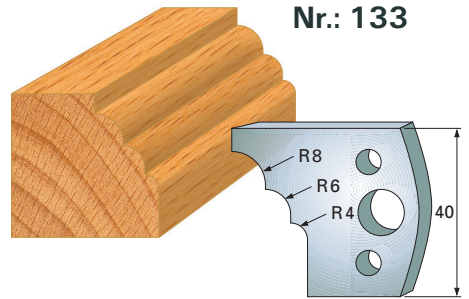

M 50403133  
A 50403333

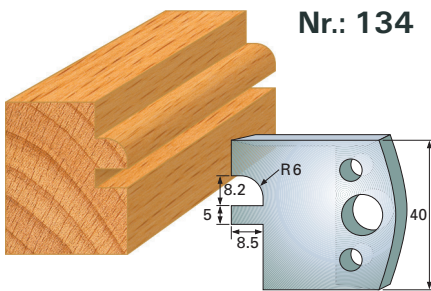

M 50403134  
A 50403334

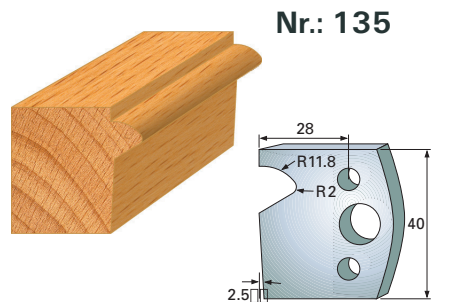

M 50403135  
A 50403335

M = Cuchillas perfiladas A = Deflectores

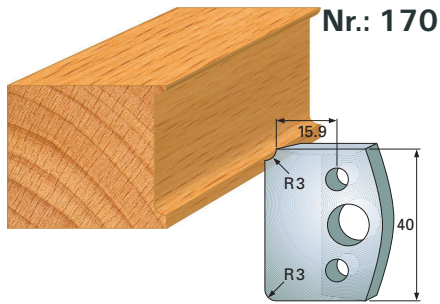

M 50403170  
A 50403370

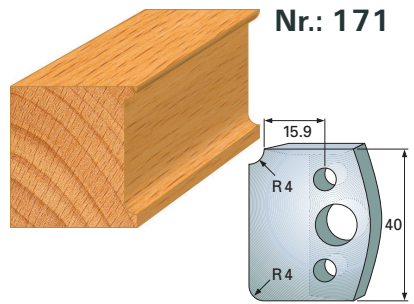

M 50403171  
A 50403371

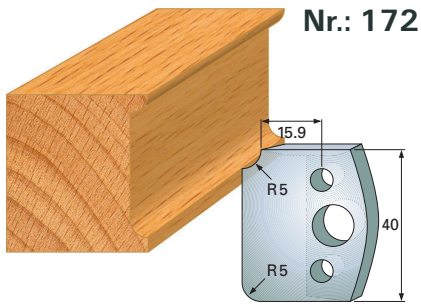

M 50403172  
A 50403372

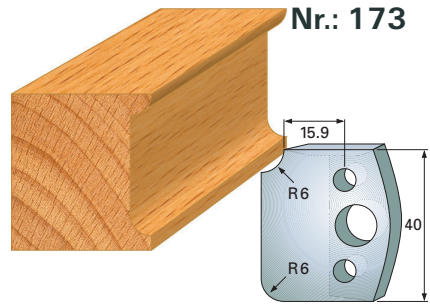

M 50403173  
A 50403373

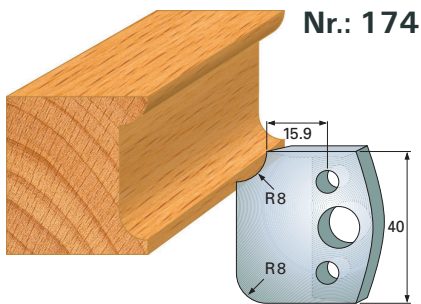

M 50403174  
A 50403374

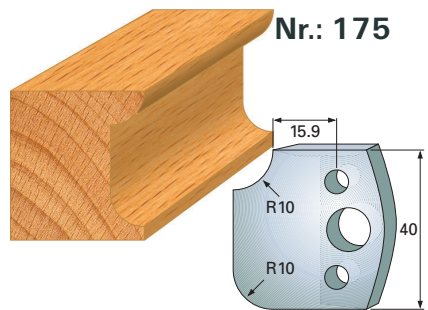

M 50403175  
A 50403375

M = Cuchillas perfiladas A = Deflectores

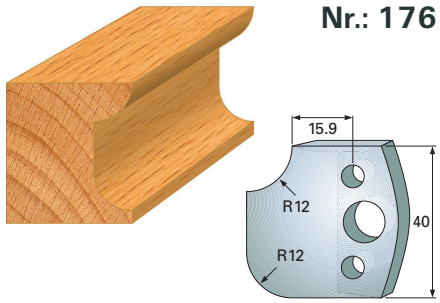

M 50403176

A 50403376

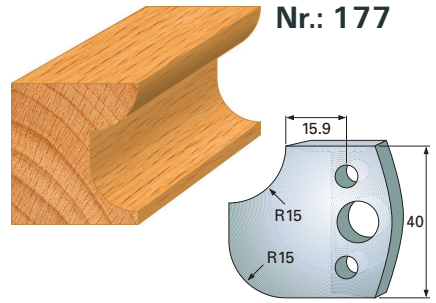

M 50403177

A 50403377

M = Cuchillas perfiladas A = Deflectores

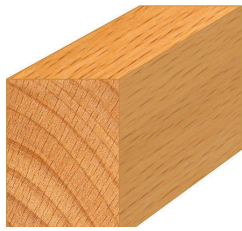

Nr.: 500

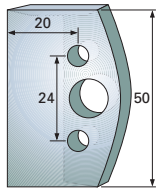

M 50503000

A 50503200

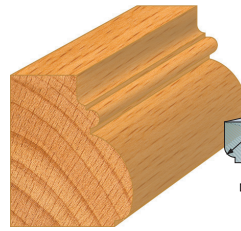

Nr.: 501

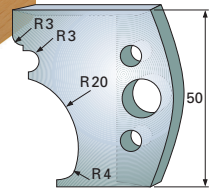

M 50503001

A 50503201

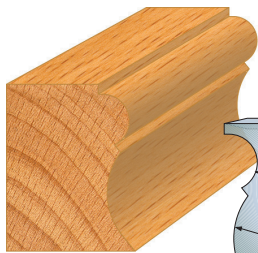

Nr.: 502

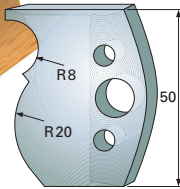

M 50503002

A 50503202



Nr.: 503

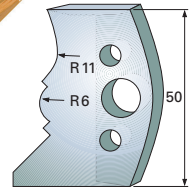

M 50503003

A 50503203

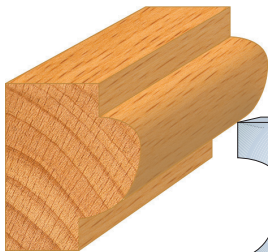

Nr.: 504

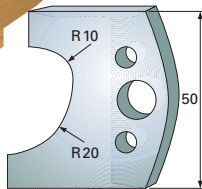

M 50503004

A 50503204

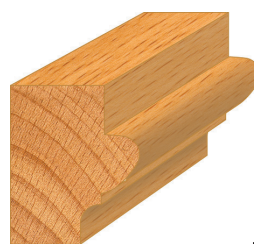

Nr.: 505

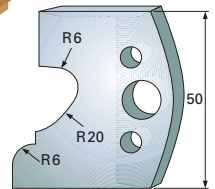

M 50503005

A 50503205

M = Cuchillas perfiladas A = Deflectores

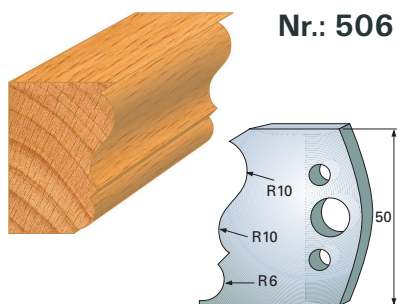

M 50503006

A 50503206

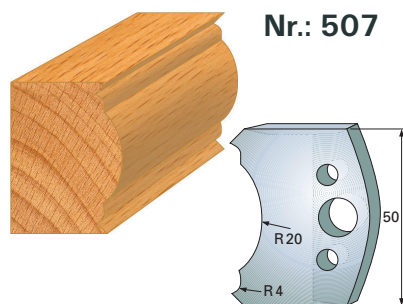

M 50503007

A 50503207

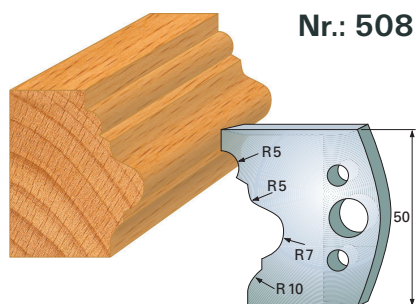

M 50503008

A 50503208

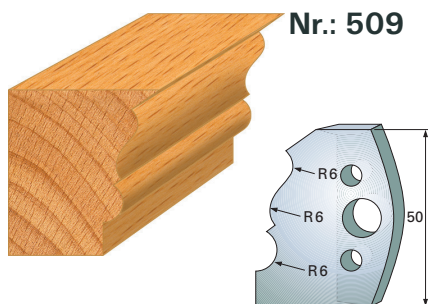

M 50503009

A 50503209

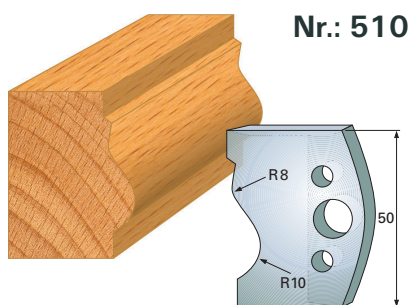

M 50503010

A 50503210

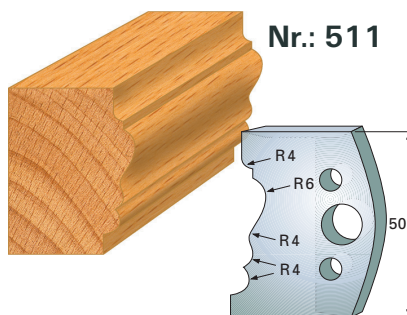

M 50503011

A 50503211

M = Cuchillas perfiladas A = Deflectores





Nr.: 512

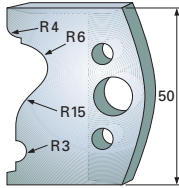

M 50503012

A 50503212

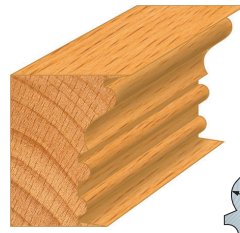

Nr.: 513

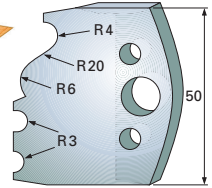

M 50503013

A 50503213

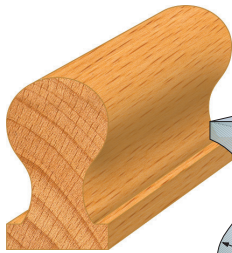

Nr.: 514

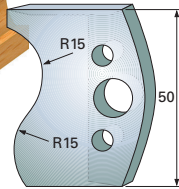

M 50503014

A 50503214

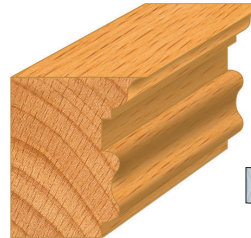

Nr.: 515

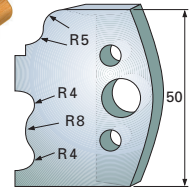

M 50503015

A 50503215

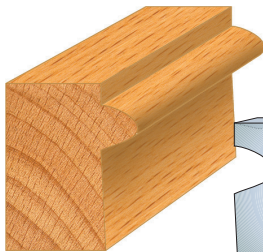

Nr.: 516

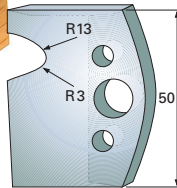

M 50503016

A 50503216

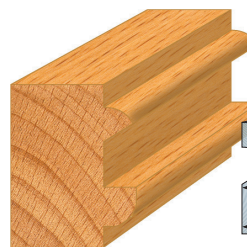

Nr.: 517

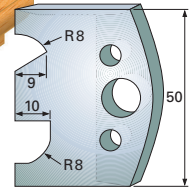

M 50503017

A 50503217

M = Cuchillas perfiladas A = Deflectores

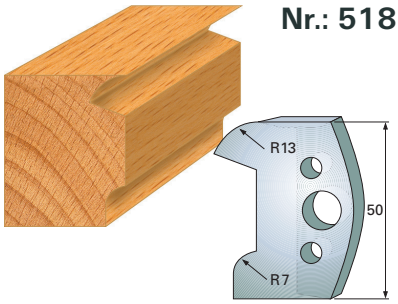

M 50503018  
A 50503218

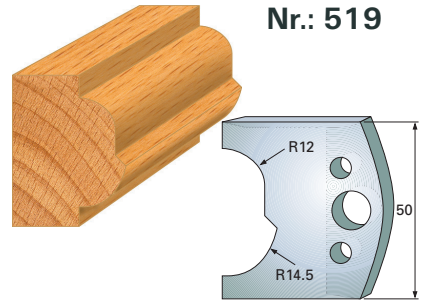

M 50503019  
A 50503219

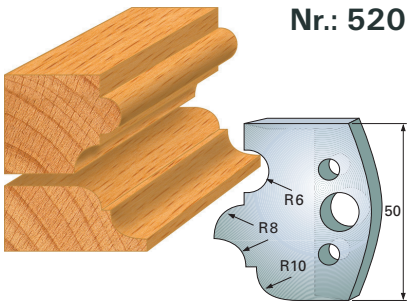

M 50503020  
A 50503220

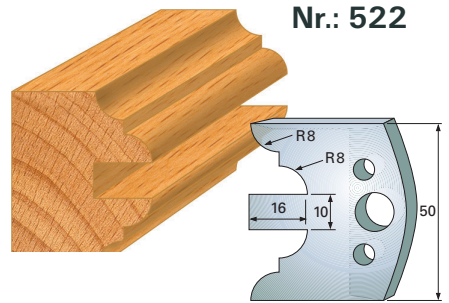

M 50503022  
A 50503222

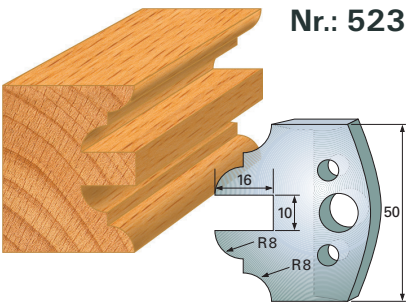

M 50503023  
A 50503223

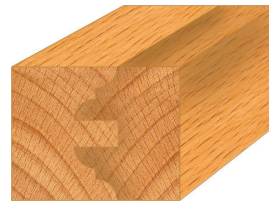

M = Cuchillas perfiladas A = Deflectores

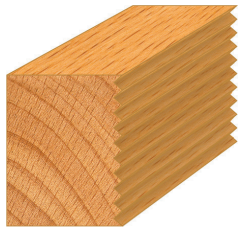

Nr.: 524

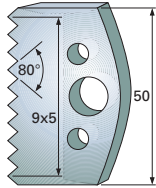

M 50503024

A 50503224



Nr.: 541

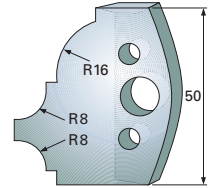

M 50503041

A 50503241

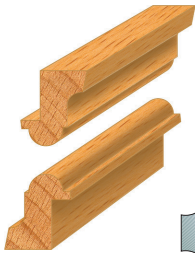

Nr.: 542

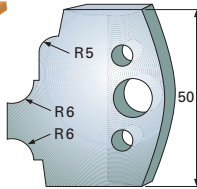

M 50503042

A 50503242

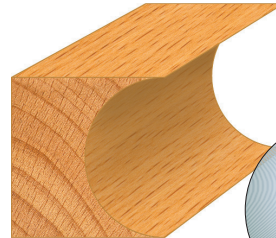

Nr.: 543

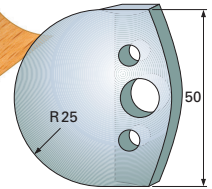

M 50503043

A 50503243

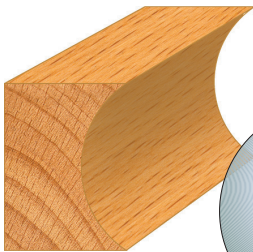

Nr.: 544

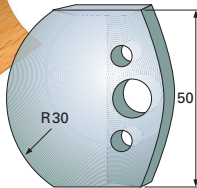

M 50503044

A 50503244

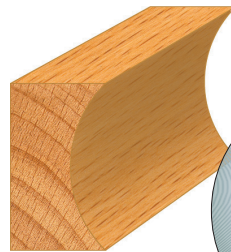

Nr.: 545

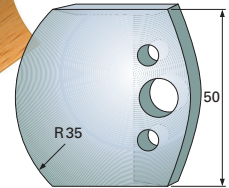

M 50503045

A 50503245

M = Cuchillas perfiladas A = Deflectores

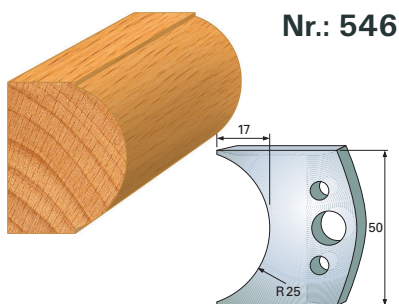

M 50503046

A 50503246

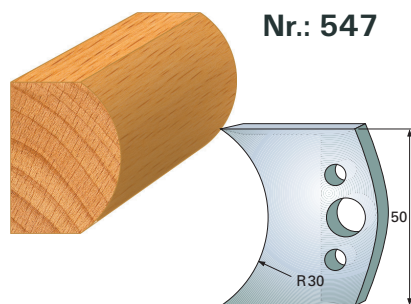

M 50503047

A 50503247

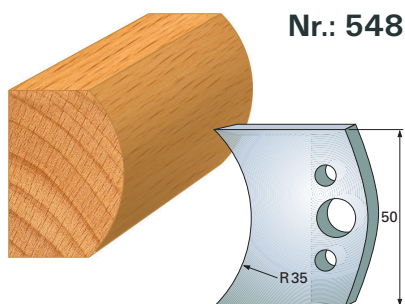

M 50503048

A 50503248

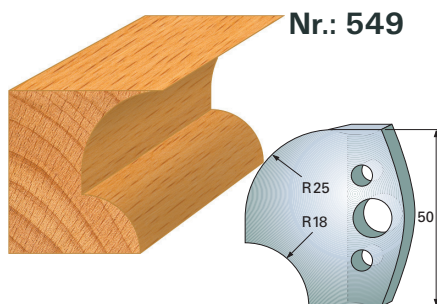

M 50503049

A 50503249

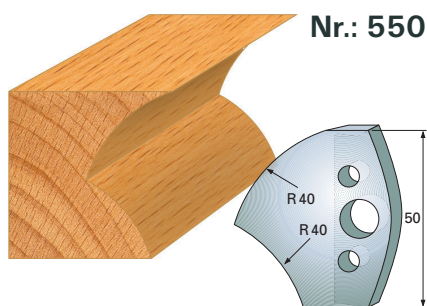

M 50503050

A 50503250

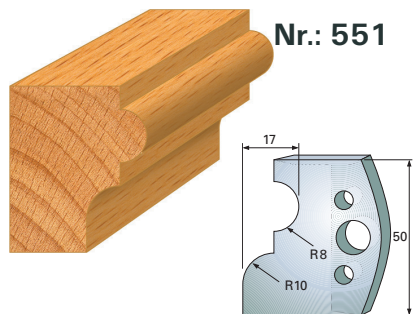

M 50503051

A 50503251

M = Cuchillas perfiladas A = Deflectores

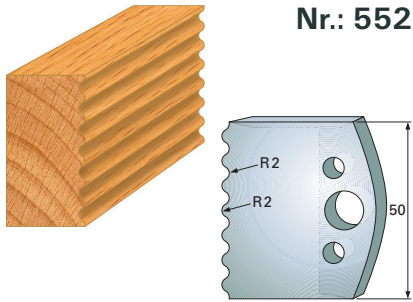

M 50503052  
A 50503252

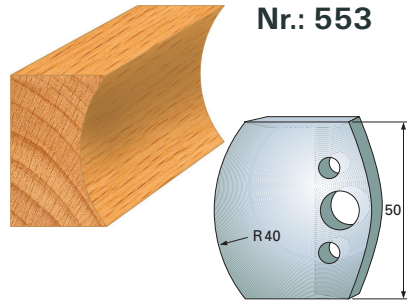

M 50503053  
A 50503253

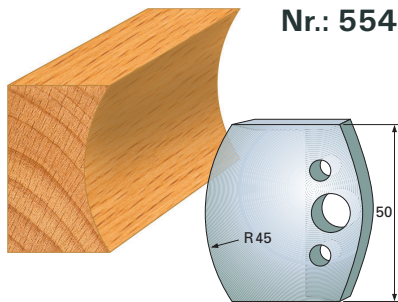

M 50503054  
A 50503254

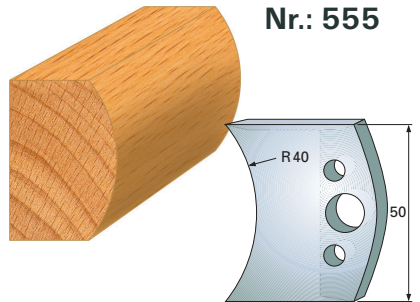

M 50503055  
A 50503255

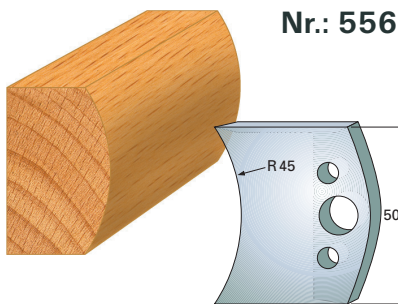

M 50503056  
A 50503256

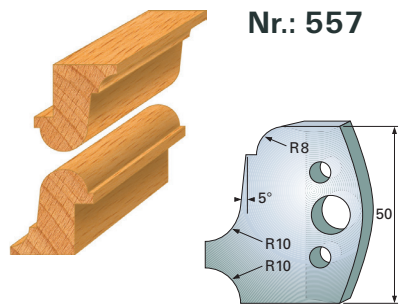

M 50503057  
A 50503257

M = Cuchillas perfiladas A = Deflectores

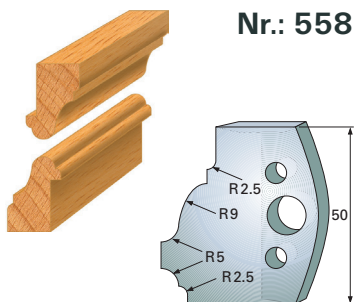

Nr.: 558

M 50503058  
A 50503258

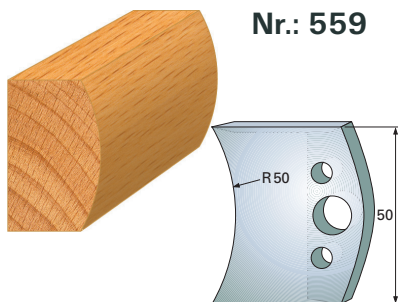

Nr.: 559

M 50503059  
A 50503259

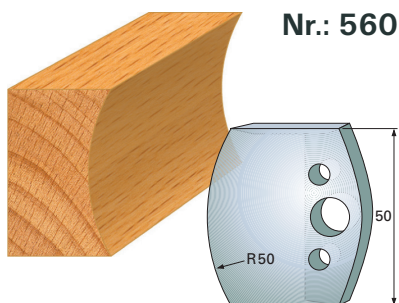

Nr.: 560

M 50503060  
A 50503260

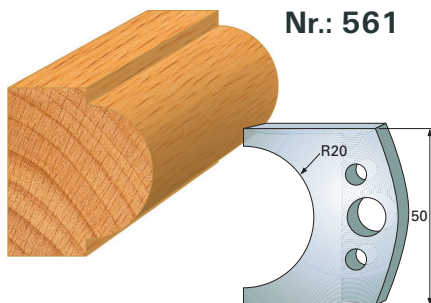

Nr.: 561

M 50503061  
A 50503261



Nr.: 562

M 50503062  
A 50503262

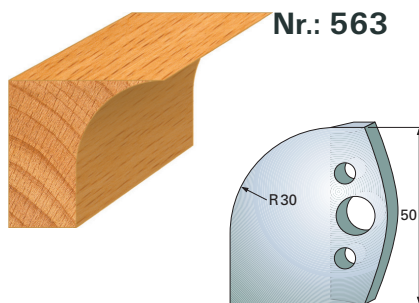

Nr.: 563

M 50503063  
A 50503263

M = Cuchillas perfiladas A = Deflectores

Nr.: 564

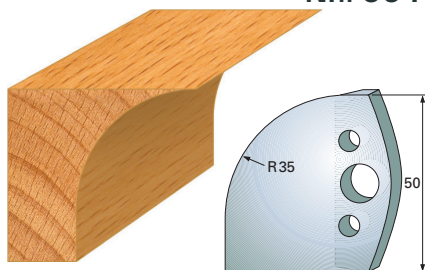

M 50503064

A 50503264

Nr.: 565

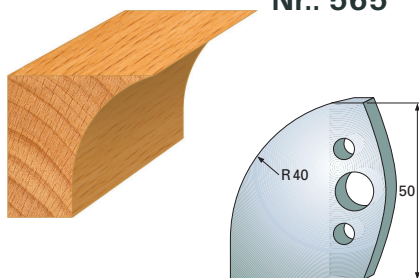

M 50503065

A 50503265

Nr.: 566

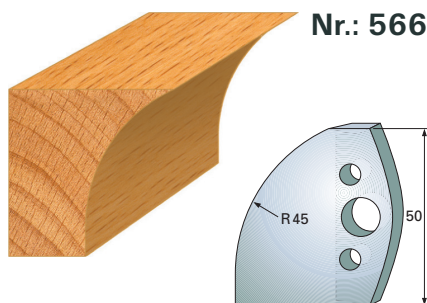

M 50503066

A 50503266

Nr.: 567

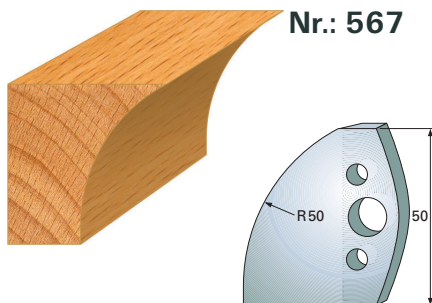

M 50503067

A 50503367

Nr.: 568

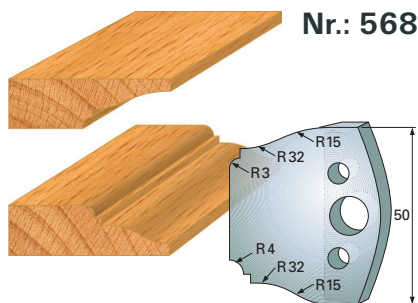

M 50503068

A 50503268

Nr.: 569

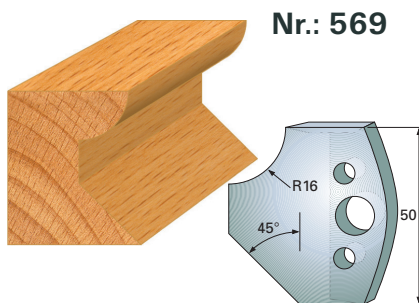

M 50503069

A 50503269

M = Cuchillas perfiladas A = Deflectores

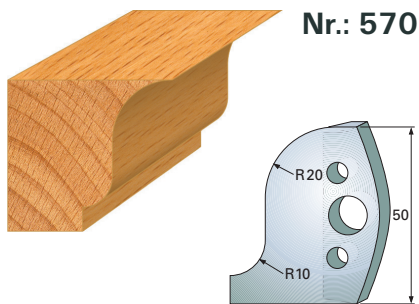

M 50503070

A 50503270

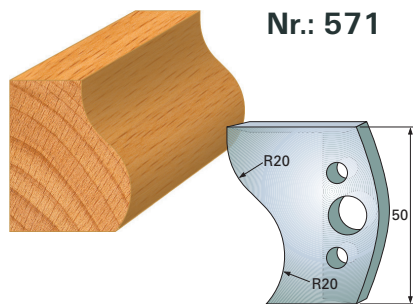

M 50503071

A 50503271

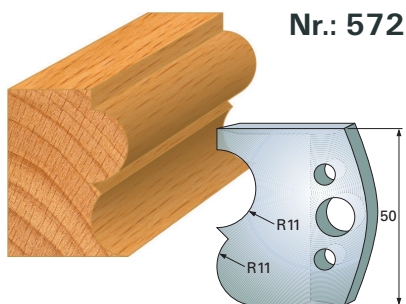

M 50503072

A 50503272

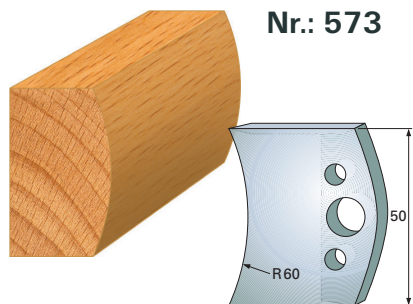

M 50503073

A 50503273

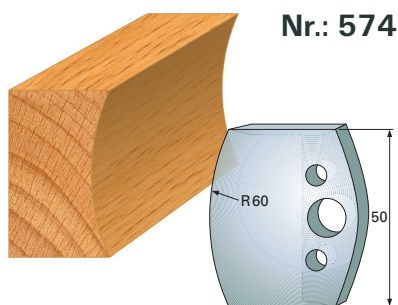

M 50503074

A 50503274

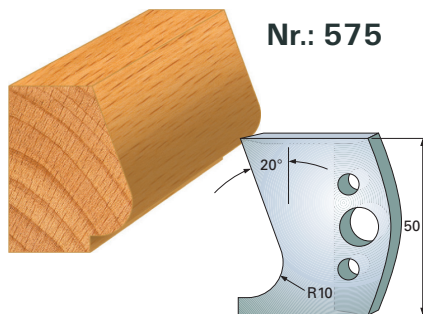

M 50503075

A 50503275

M = Cuchillas perfiladas A = Deflectores



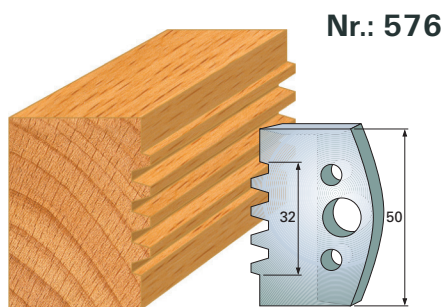

M 50503076

A 50503276

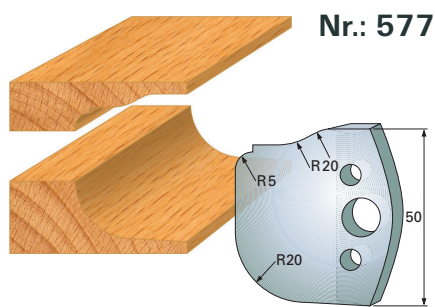

M 50503077

A 50503277

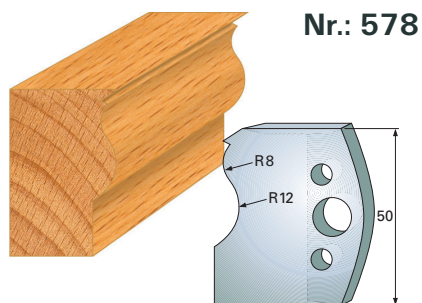

M 50503078

A 50503278

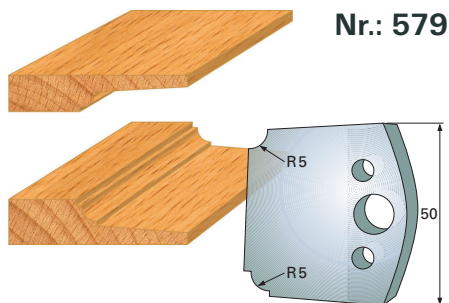

M 50503079

A 50503279

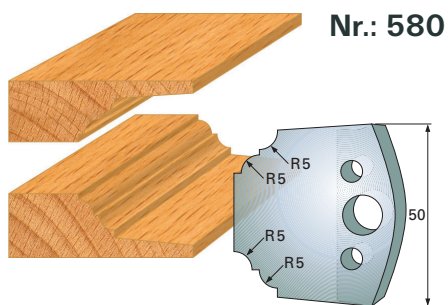

M 50503080

A 50503280

M = Cuchillas perfiladas A = Deflectores

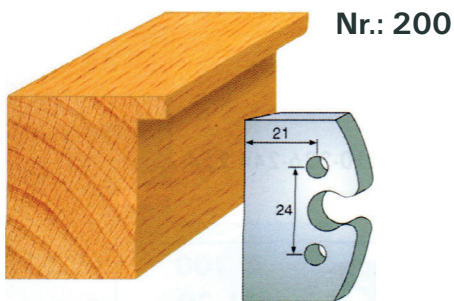

M 54030200  
A 54032200

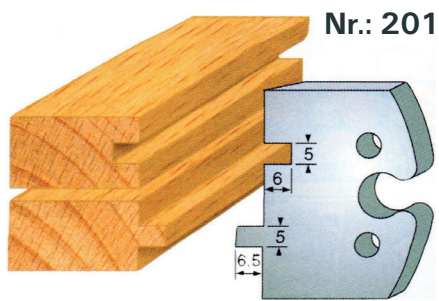

M 54030201  
A 54032201

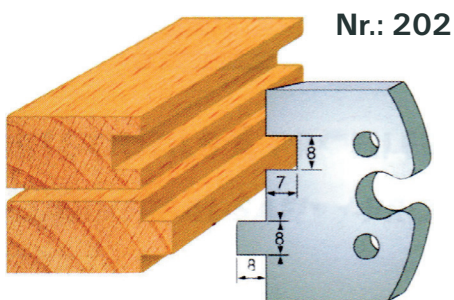

M 54030202  
A 54032202

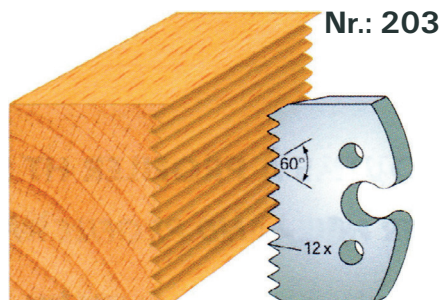

M 54030203  
A 54032203

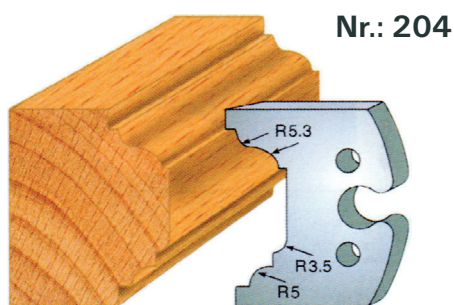

M 54030204  
A 54032204

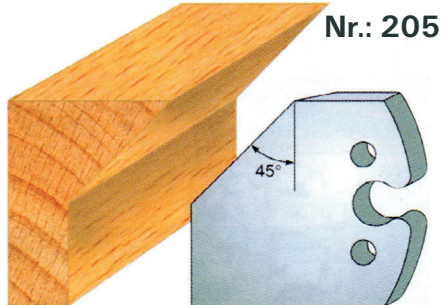

M 54030205  
A 54032205

M = Cuchillas perfiladas A = Deflectores

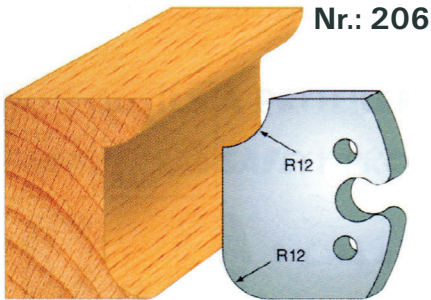

M 54030206  
A 54032206

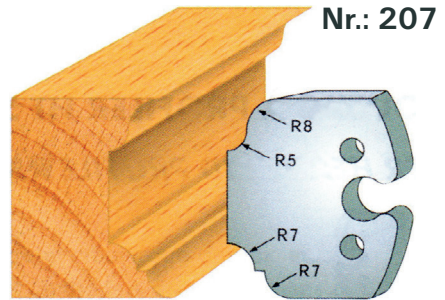

M 54030207  
A 54032207

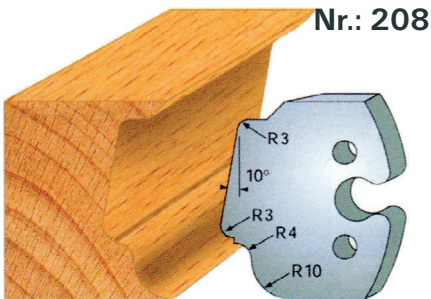

M 54030208  
A 54032208

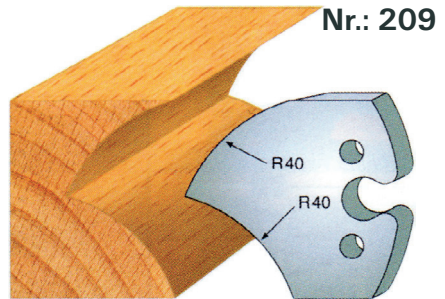

M 54030209  
A 54032209

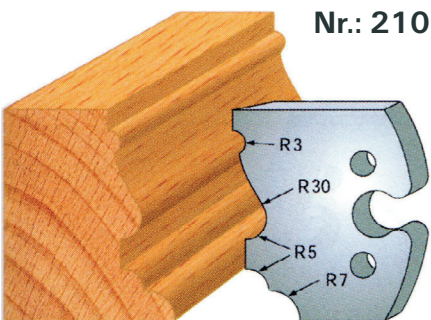

M 54030210  
A 54032210

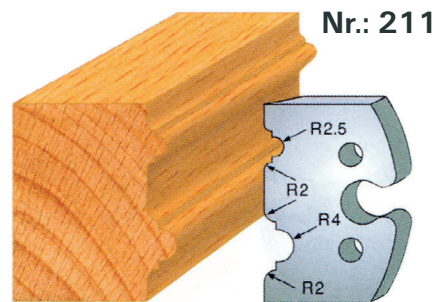

M 54030211  
A 54032211

M = Cuchillas perfiladas A = Deflectores

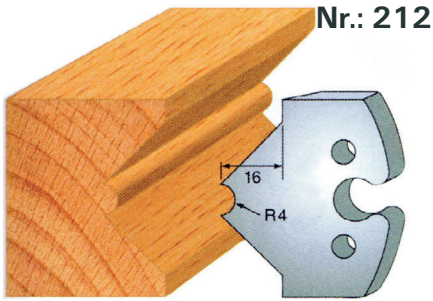

M 54030212  
A 54032212

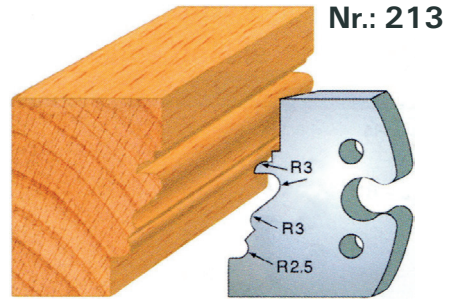

M 54030213  
A 54032213

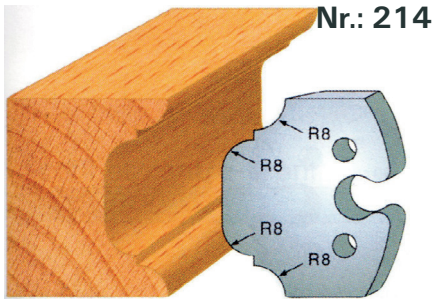

M 54030214  
A 54032214

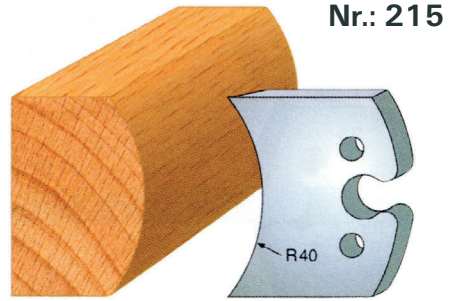

M 54030215  
A 54032215

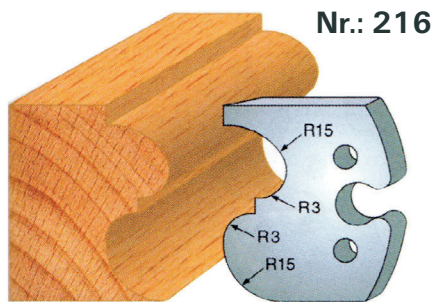

M 54030216  
A 54032216

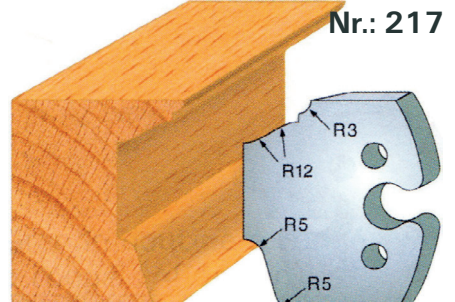

M 54030217  
A 54032217

M = Cuchillas perfiladas A = Deflectores

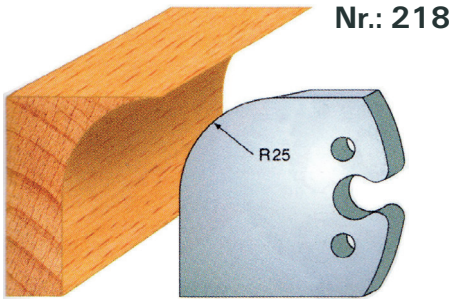

M 54030218  
A 54032218

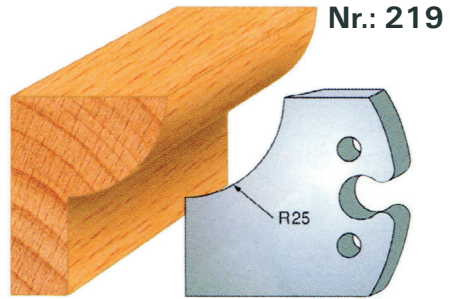

M 54030219  
A 54032219

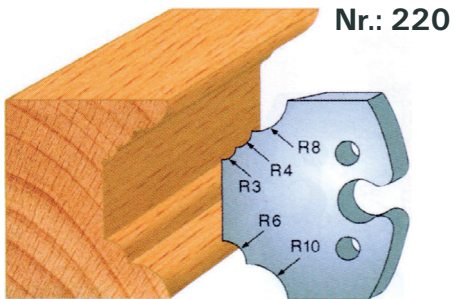

M 54030220  
A 54032220

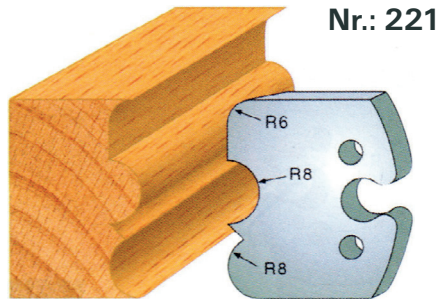

M 54030221  
A 54032221

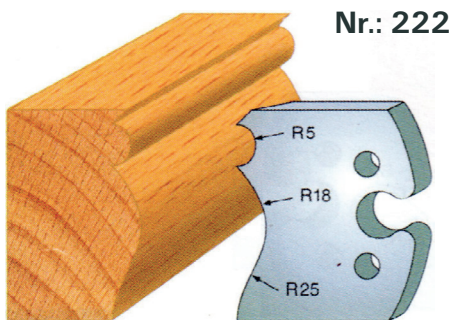

M 54030222  
A 54032222

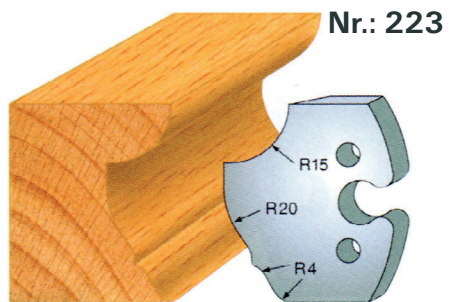

M 54030223  
A 54032223

M = Cuchillas perfiladas A = Deflectores

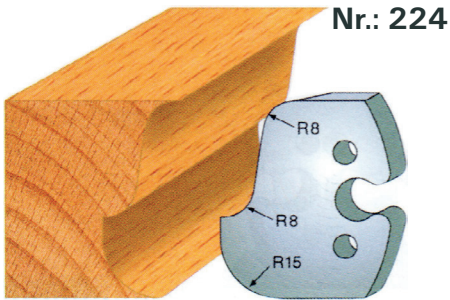

M 54030224  
A 54032224

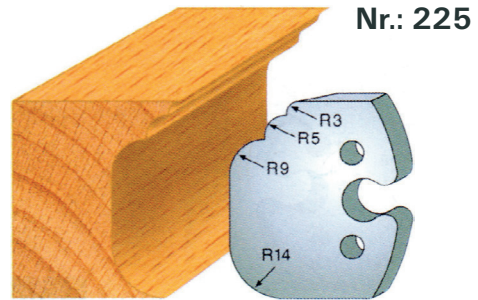

M 54030225  
A 54032225

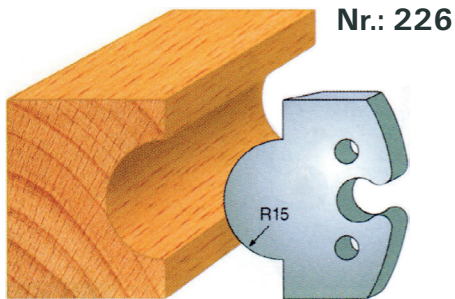

M 54030226  
A 54032226

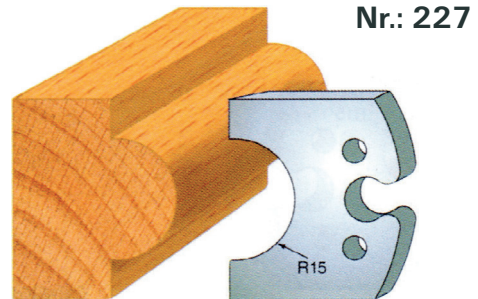

M 54030227  
A 54032227

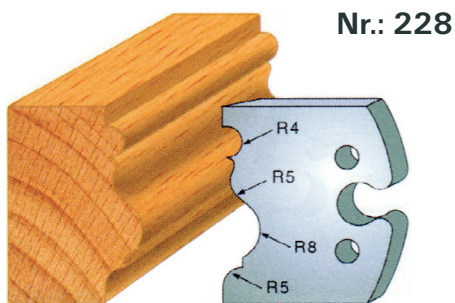

M 54030228  
A 54032228

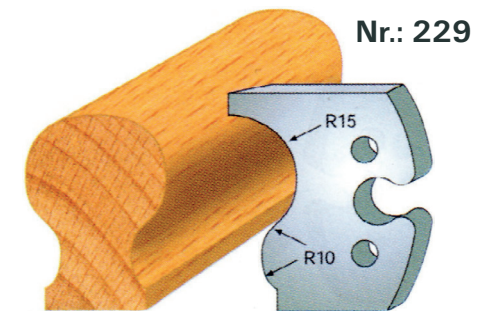

M 54030229  
A 54032229

M = Cuchillas perfiladas A = Deflectores

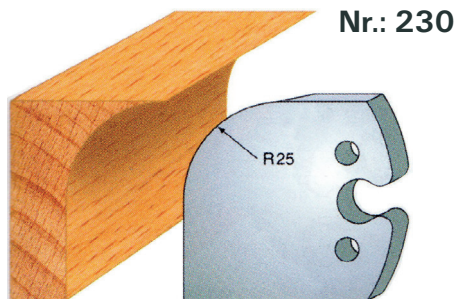

M 54030230  
A 54032230

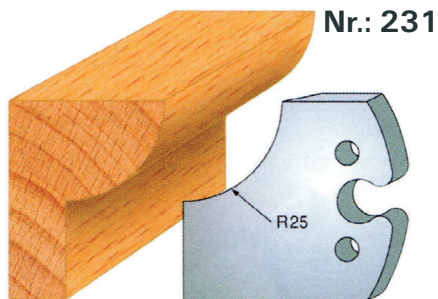

M 54030231  
A 54032231

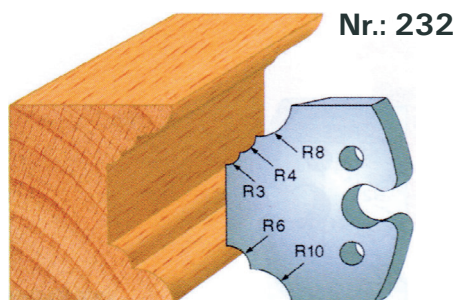

M 54030232  
A 54032232

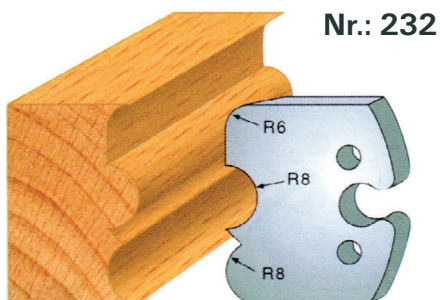

M 54030232  
A 54032232

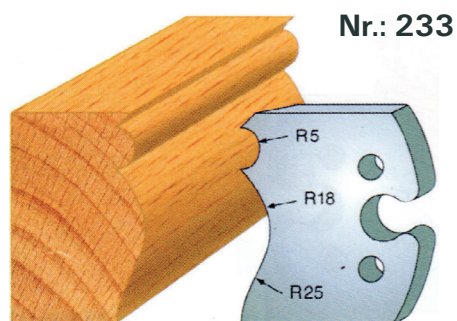

M 54030233  
A 54032233

M = Cuchillas perfiladas A = Deflectores

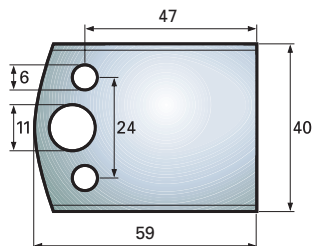
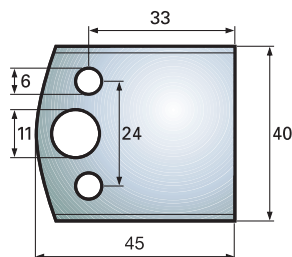

## Características

40 x 45 x 4 mm HSS

40 x 59 x 4 mm HSS

## Cuchillas sin perfilar

M 40304045

M 40304059

## Deflectores

A 40324045

A 40324059

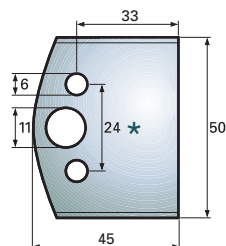
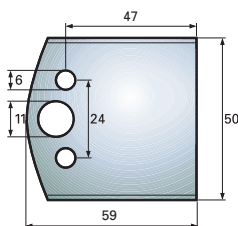
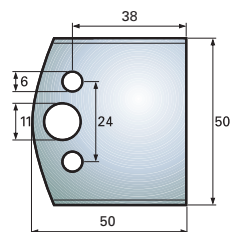

## Características

50 x 45 x 4 mm HSS

50 x 59 x 4 mm HSS

50 x 45 x 5,5 mm HSS\*

## Cuchillas sin perfilar

M 40305045

M 40305059

M 40305045\*

## Deflectores

A 40325045

A 40325059

A 40325045\*

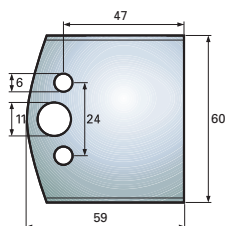
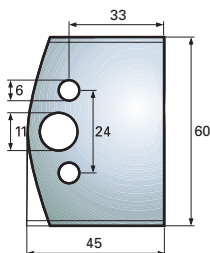

## Características

60 x 45 x 4 mm HSS

60 x 59 x 4 mm HSS

## Cuchillas sin perfilar

M 40306045

M 40306059

## Deflectores

A 40326045

A 40326059



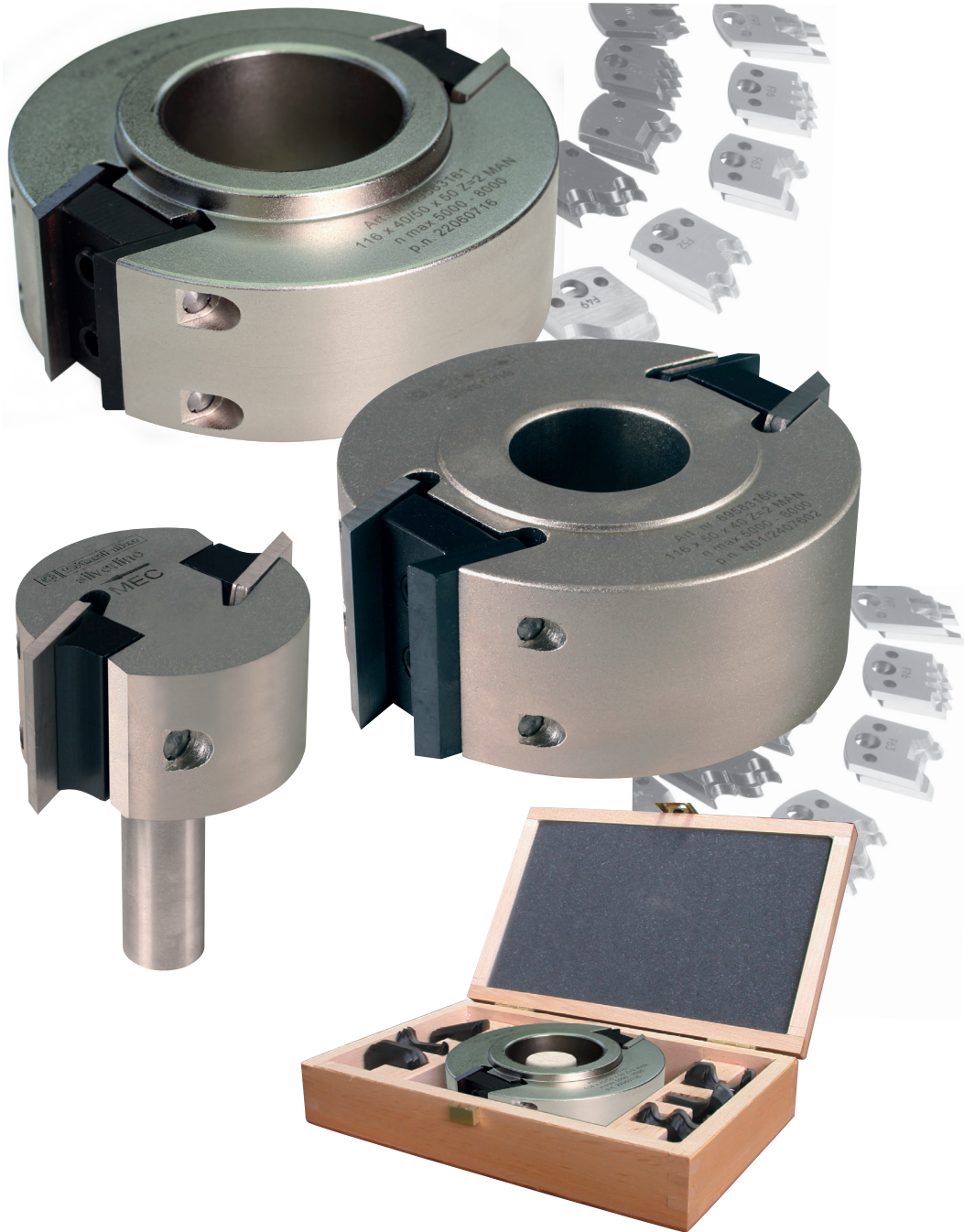





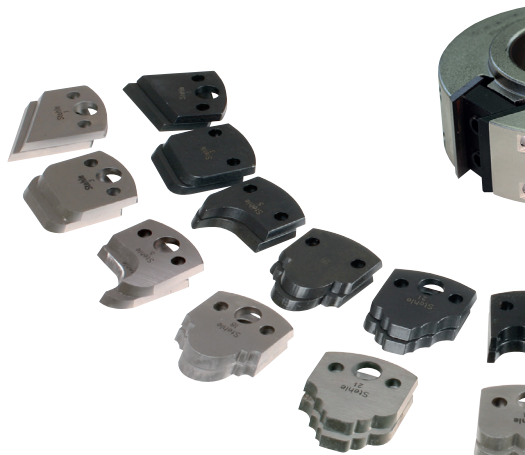

Ihr Fachhändler: